

EasyLogic™ Power metering Catalog

A complete range of meters for essential electrical system measurement



Panorama of the EasyLogic range	3
DM1000 series	
1-Ph Volts Amps Frequency Digital Panel Meters	5
DM3000 series	
3-Ph Volts Amps Digital Panel Meters	5
DM6xx0H series	
VAF PF Digital Panel Meters	7
PM1000H series	
Basic Power & Energy Meters	13
PM1130H / PM1230H series	
Dual Source Power & Energy Meters	19
PM2100 & PM2200 series	
Power & Energy Multi-Function Meters	25
PM2200R Quick Click series	
Multi-function Power & Energy meter with Quick Click CTs	36
Commercial reference numbers See your Schneider Electric representative for complete ordering information	45

Panorama of the EasyLogic range

Digital panel meters



Family	DM1000			DM3000		DM6000H	
Parameters	DM1110	DM1210	DM1310	DM3110	DM3210	DM6000H	DM6200H
Amps: per phase & 3-ph avg	1-ph			3-ph (per ph)		■	■
Volts: per phase & 3-ph avg		1-ph			3-ph (per ph)	■	■
Frequency			■			■	■
Power Factor per phase & 3-ph avg						■	■
CT Secondary I nominal	5A or 1A			5A or 1A		5A or 1A	5A or 1A
Class of Accuracy	0.5	0.5	0.2	0.5	0.5	1	1
RS-485 Modbus RTU							■
Form Factor in mm (LengthxWidthxDepth)	96x96x44	96x96x44	96x96x44	96x96x44	96x96x44	96x96x49	96x96x49
Mounting	Flush/Panel	Flush/Panel	Flush/Panel	Flush/Panel	Flush/Panel	Flush/Panel	Flush/Panel

Simple energy cost management							
Data aggregation							■
Load profile							■
Bill verification							
Cost allocation							

Basic network management							
Panel instrumentation	■	■	■	■	■	■	■
Power metering							
Basic harmonic monitoring							
Status monitoring							
Threshold alarming							

Monitoring and verification							
Test bench	■	■	■	■	■	■	■
Genset	■	■	■	■	■	■	■
PF Improvement panel						■	■
Labs	■	■	■	■	■	■	■
OEMs	■	■	■	■	■	■	■
Comm. ref. no.	METSEDM1110	METSEDM1210	METSEDM1310	METSEDM3110	METSEDM3210	METSEDM6000 HCL10NC	METSEDM6200 HCCL10RS METSEDM6220HCL1

Panorama of the EasyLogic range

Digital panel meters (contd.)



Family	PM1120H	PM1130H	PM2100 LED	PM2200 LCD	PM2200R
Parameters					
Amps: per phase & 3-ph avg	■	■	■	■	■
Volts: per phase & 3-ph avg	■	■	■	■	■
Frequency	■	■	■	■	■
Power Factor per phase & 3-ph avg	■	■	■	■	■
W, Wh	■	■	■	■	■
VAR, VARh	□	□	■	■	■
VA, VAh	□	□	■	■	■
DI/DO (optional)			2 (PM2130)	2 (PM2230)	
Class of Accuracy*	1.0 active (0.5 optional)	1.0 active (0.5 optional)	1.0 active (0.5S PM2x30) 1.0 reactive	1.0 active (0.5S PM2x30) 1.0 reactive	1.0 active
Analog IO A (optional)			2 (PM2130)	2 (PM2230)	
RS-485 Modbus RTU	■	■	■	■	■
CT Secondary I <i>nominal</i>	5 A or 1 A	5 A or 1 A	5 A or 1 A	5 A or 1 A	5 A or 1 A
Form Factor in mm	96x96x49	96x96x52	96x96x54	96x96x54	96x96x54
With IO module			96x96x72	96x96x72	
Mounting	Flush/Panel	Flush/Panel	Flush/Panel	Flush/Panel	Flush/Panel

Simple energy cost management

Data aggregation	■	■	■	■	■
Load profile			■	■	■
Bill verification	■	■	■	■	■
Cost allocation	■	■	■	■	■

Basic network management

Panel instrumentation	■	■	■	■	■
Power metering	■	■	■	■	■
Basic harmonic monitoring	■	■	■	■	■
Status monitoring			■	■	
Threshold alarming		■	■	■	

Monitoring and verification

Test bench	■	■	■	■	■
Genset	■	■	■	■	■
PF Improvement panel	■	■	■	■	■
Labs	■	■	■	■	■
OEMs	■	■	■	■	■
Comm. ref. no. (Link to product information)	METSEPM1120HCL10RS METSEPM1125HCL10RS METSEPM1225HCL10RS METSEPM1125HCL1LVD METSEPM1225HCL1LVD	METSEPM1130HCL05RS METSEPM1230HCL1 METSEPM1230HCL5LVD	METSEPM2110 METSEPM2120 METSEPM2130	METSEPM2210 METSEPM2220 METSEPM2230	METSEPM2210R METSEPM2220R METSEPM2230RCL05

* Refer data sheet for operating range

□ One power vector at a time (W/Wh or VA/VAh or VAR/ VARh in PM1120H and Three power vector in PM1125H/ PM1225H)

EasyLogic™

DM1000/3000 series

The EasyLogic™ DM1000 series : 1-Ph V A F panel meters, DM3000 series: 3-Ph V A panel meters

The universal, user-programmable DM1000 and DM3000 series panel meters for AC circuits are ideal replacements for analog meters. These five compact, flexible and customizable models will meet all your panel metering requirements.

PB113034



DM1000/3000

PB113034



DM1000 series digital panel meter

PB113048



DM3000 series digital panel meter front display (above), and rear (below)

PB113044



- Basic VAF panel meters – main features
 - 4 digit, 15 mm height, 7 segment LED display
 - 1-ph & 3-ph Volt or Amps panel meters
 - Accuracy of 0.5 % on full scale for Volt & Ammeter, 0.2 % for Hz meter
 - Inbuilt selector switch in 3-ph meter model
 - Single key for programming, navigation or as selector switch
- Basic VAF panel meters – technical specifications
 - Input voltage (50 Hz/ 60 Hz ± 5 %)
 - 80 to 480 V AC L-L direct, up to 999 kV with PT
 - Input current (50 Hz/ 60 Hz ± 5 %)
 - 50 mA to 6 A direct, CT secondary 1 A or 5 A field settable
 - Overload current: 10 A continuous
 - CT primary: 1 A to 99 kA field settable
 - Control power
 - 44 to 300 V LN AC (50 Hz/ 60 Hz) or DC
 - Form factor
 - Flush/panel mount, 96 x 96 x 44 mm
 - IP Degree of protection
 - IP51 front & IP30 rear side
 - Auto scaling & direct readings
 - Accuracy
 - 0.5 % of full scale for V & A
 - 0.2 % of full scale for Hz
 - Safety/ EMI-EMC tests
 - Certifications:
 - CE: As per IEC 61010-1 Ed.3
 - Standards:
 - Emission: CISPR11, Class A
 - Electrostatic Discharge: IEC 61000-4-2*
 - Surge: IEC 61000-4-5*
 - Electrical Fast Transients: IEC 61000-4-4*
 - Radiated susceptibility: IEC 61000-4-3*
 - Conducted susceptibility: IECX 61000-4-6*
 - Power frequency magnetic field: IEC 61000-4-8*
 - Immunity to voltage dips and interruptions: IEC 61000-4-11*
 - Harmonic current emissions: IEC 61000-3-2*
 - Voltage fluctuations and flicker: IEC 61000-3-3*
 - Safety: Self extinguishable V1 plastics, measurement category III, Pollution degree 2
 - Temperature
 - Operating: -10 °C to 60 °C (14 °F to 140 °F)
 - Storage: -25 °C to 70 °C (-13 °F to 158 °F)
 - Weight: 220 g approx, unpacked; 400 gms approx, shipping
 - Panel cut out: 92 x 92 mm Flush mount
 - LED indicators for phase identification in 3-ph meters

Parameter	DM1110	DM1210	DM1310	DM3110	DM3210	Accuracy
1-ph A	■					0.5 %
1-ph V		■				0.5 %
1-ph Hz			■			0.2 %
3-ph A				■		0.5 %
3-ph V					■	0.5 %
Commercial ref number	METSEDM 1110	METSEDM 1210	METSEDM 1310	METSEDM 3110	METSEDM 3210	

* As per IEC 61326-1

EasyLogic™ DM6xx0H series

DM6000H & DM6200H VAF PF digital panel meters in LED display

DM6220H VAF PF digital panel meters in LCD display

Introducing EasyLogic™ DM6xx0H meters that are ideal replacements for multiple analog meters for stand-alone metering in custom panels, switch boards, switch-gear, genset panels, motor control centres, power factor improvement panels, and OEM panel board.

DM6xx0H series meters offer large 8-segment alpha-numeric LED display type, intuitive navigation with self-guided 4 buttons, bright LED's of 14.2 mm height with 12 LEDs for indicating percentage of load in the circuit.

DM6220H meter displays measured parameters and values in elegant single row, bright back lit graphical LCD display in 128 * 32 pixels size.



METSEDM6000HCL10NC



METSEDM6220HCL1

PB119316

PB120600

DM6xx0H



Front view DM6220H with LCD display



Front view DM6000H with LED display



Rear ISO DM6000H non comm

• Applications

- Cost management
 - Electrical installation remote monitoring
 - Control panels
 - Motor control centres
 - Power distribution boards
 - Original equipment manufacturers (OEM's)
 - Building management system
 - Panel instrumentation
 - Energy management system

• Network management

- Measurement of Power factor
- % unbalance for voltage and current
- Phase angle between the respective voltage and current phase
- Modbus RTU protocol, RS-485 communication port for integration with energy management systems (DM6200H & DM6220H)

• Main characteristics

- Easy to install: Mounts using two retainer clips, no tools required. Compact meter with 49 mm meter depth behind the panel, connectable up to 480 V +10 % AC volts L-L without voltage transformers for installation compliant with measurement category III, and double insulated
- Easy to operate: Intuitive navigation with self-guided menus and Heartbeat LED indicates normal functioning of meters while it conveys the communication status when connected to RS-485 network
- LED display: Intuitive navigation with self-guided, four buttons, 8 segment alphanumeric LEDs of height ~14.2mm (0.55 in) and three lines of concurrent values with Kilo & Mega value indicators
- LCD display: Elegant single row, bright back lit graphical LCD display 128 * 32 pixels, Fast in-line view, three parameters name and value at one glance
- Standard compliance:
 - EMI/EMC tests as per IEC 61326-1
 - CE certification as per IEC 61010-1 Edition 3
 - cULus as per UL61010-1 and CAN/CSA-C22.2 IEC 61010-1 edition 3, for 480 V AC L-L
 - Accuracy class 1.0 for V AF PF metering
 - CT nominal: 5 A, I-nominal or 1 A, I-nominal (field settable)
 - Password: Field configurable password for securing set up information
 - Cyber security: Option for disabling RS-485 port through front panel keys against unauthorized access. This feature can also be used for maintenance and troubleshooting of complex communication network
 - Analog load bar in LED display: the colour-coded analog load bar at the front side indicates the percentage of load through 12 LED's with the option to select full scale based on connected load
 - Display: 4 digits for VAF PF parameters with auto scale and auto range features
 - Suppression current: To disregard the measurement of induced and panel auxiliary load current in the circuit (settable from 5 to 99 mA)
 - Protection cover to ensure that terminal screws do not detach from the housing and are touch proof against fingers
 - Smart line indicators in LCD display meter: helps check the presence of input supply voltage (healthy phase)
 - Control power options: Universal range 44 to 300 V L-N AC/DC or low voltage DC control power of 9 to 36 V DC

DM6xx0H

DM6xx0H technical specifications

General	
Use on LV & MV systems with Potential transformer (PT or VT) / Current transformer (CT) ratio programmable at site	
Digital panel meters for measurement of basic electrical parameters	
Instantaneous rms values	
Current	Average line current of 3-phase, per-phase, and calculated neutral current
Voltage	Average voltage of L-L, L-N parameters, and per-phase
Frequency	Any available line
True power factor	Average and per-phase signed
Unbalance	Maximum % unbalance among phases for Volts & Amps
Revolution per minute (RPM)	RPM of alternator or generator when number of poles set for 2, 4, 6, 8, 12, 14 or 16 (any one pole)
Life timer stored in non-volatile memory	
Time counters for measuring meter ON Hrs and power interruptions	
Display	
LED display: Bright red colour, 8 segment alphanumeric LED, ~ 14.2 mm (0.55 in) height, 3 rows with 4 digits per row, auto range, auto scale	
LCD display: Elegant single row, bright back lit graphical LCD display 132 (Horizontal) * 32 (Vertical) pixels, 60 Degree angular view. Fast in-line view, three parameters name and value at one glance	
Communication	
RS-485 serial (DM6200H)	Channel connection Industry standard Modbus RTU protocol
Integration with software	Any Modbus compatible SCADA / DCS / PMS / EMS / BAS / BMS software
Native Plug and Play support	Schneider Electric energy management system software - EcoStruxure™ Power Monitoring Expert, EcoStruxure™ Power SCADA Operation ION Setup utility software for set-up/programming of meters
Diagnostics	
Diagnostic page	Diagnostic page indicates the healthiness of communication system, device serial number, device model number OS & RS version, communication status. All LED segment check in LED display. In LCD display meter - alternate pixels ON/ OFF test. LCD contrast level, set back-lit time out in the range of 1 to 99 sec.
Lock / Un-Lock	
Page lock and unlock features	Once the commonly referred page is enabled for lock feature, the display returns to locked page in 4 minutes of inactive time
Electrical characteristics	
Type of measurement	True RMS, 32 samples/cycle
Measurement accuracy (Class 1.0 meters)	
Current, per-phase & average	± 0.5 % of reading
Voltage, L-N, L-L, per-phase & average	± 0.5 % of reading
Power factor, per-phase & average	± 0.01 of reading
Frequency	± 0.05 % for F-nominal 50/60 Hz ± 2 ± 0.2 % for Frequency range from 30 to 48 Hz, 52 to 58 Hz and 62 to 70 Hz
Input-voltage	
VT (PT) connection	Selectable from No VT (direct), 1 VT, 2 VT to 3 VT
VT (PT) primary	100 V L-L to 999 kV L-L max
U (V) nominal	Up to 277 V L-N/ 480 V L-L (selectable VT secondary from 100, 110, 115, 120 to 415 V L-L)
Operating voltage range with accuracy	80-480 V L-L ± 10 % Category III
Measured Voltage with full range	35 to 600 V L-L
Permanent overload (withstand)	750 V L-L, continuous
Impedance	≥5 MΩ
Frequency	50/60 Hz ± 2
VA burden	≤0.2 VA at 240 V L-N at 50 Hz
Frequency – measurement	
Nominal operating range	50/60 Hz ± 2
Extended operating range	30 to 48 Hz, 52 to 58 Hz and 62 to 70 Hz
Voltage input	80 to 480 V L-L ± 10 %

Comparisons

Parameters / Model	DM6000H Class 1.0 44 to 300 V AC/DC control power	DM6200H Class 1.0 44 to 300 V AC/DC control power	DM6220H Class 1.0 44 to 300 V AC/DC control power	DM6220H Class 1.0 9 to 36 V LVDC control power
V A F – per ph & Avg	■	■	■	■
PF – per ph & Avg	■	■	■	■
% Load, % V & I Unbal, Ph-angle, RPM	■	■	■	■
Modbus RS-485		■	■	■
Commercial reference no.	METSEDM6000HCL10NC	METSEDM6200HCL10RS	METSEDM6220HCL1	METSEDM6220HCL1LVD

DM6xx0H

Input-current	
CT connect	Solo or multi-phase current measurement by installing CT (s) in either of A1, A2, A3, A12, A23, A13, A123 phase(s)
CT primary	1 A to 32767 A, programmable
CT secondary	1 A or 5 A I-nominal (field settable)
Operating current range with accuracy	10 mA to 6 A ⁺¹
Measured Amps with over range & Crest Factor	5 mA to 10 A
Suppression current	5 to 99 mA (to disregard negligible load)
Impedance	< 0.3 mΩ
Permanent overload (withstand)	Continuous 10 A, 10 s/hr 50 A, 1 s/hr 500 A
Frequency	50/60 Hz ± 2
VA Burden	≤0.1 V A at 5 A at 50 Hz
AC control power	
Operating range	48 to 277 V L-N AC ± 10 %
Burden	≤4 VA at 240 V L-N 50 Hz
Frequency	50/60 Hz nominal (45 to 65 Hz operating range)
Ride-through time	200 milliseconds at 240 V L-N, 50 Hz
DC control power	
Operating range	48 to 277 V DC ± 10 % or LVDC option of 9 to 36 V DC
Burden	≤2 W at 240 V DC
Ride-through time	120 milliseconds at 240 V
Displays update	
Instantaneous/ RMS parameters	1 s
Power system	
Phase labelling	Configurable to 123, ABC, rst, pqr or ryb
Wiring configuration	13 wiring schemes (5 on front screen) 1ph, 2w, L-N 1ph, 2w, L-L 1ph, 3w, L-L with N (2-phase) 3ph, 3w, Delta, Ungrounded 3ph, 3w, Delta, Corner Grounded ⁺² 3ph, 3w, Wye, Ungrounded ⁺² 3ph, 3w, Wye Grounded ⁺² 3ph, 3w, Wye, Resistance Grounded ⁺² 3ph, 4w, Open Delta, Centre-Tapped ⁺² 3ph, 4w, Delta, Centre-Tapped ⁺² 3ph, 4w, Wye, Ungrounded ⁺² 3ph, 4w, Wye Grounded 3ph, 4w, Wye, Resistance Grounded ⁺²

⁺¹ Additional error of ± 2 % between 10 mA to 50 mA, ± 1 % between 50 mA to 100 mA

⁺² Through communication

Feature set summary				
Parameter	DM6000H Class 1.0 44 to 300 V AC/DC control power	DM6200H Class 1.0 44 to 300 V AC/DC control power	DM6220H Class 1.0 44 to 300 V AC/DC control power	DM6220H Class 1.0 9 to 36 V LVDC control power
Sampling rate per cycle	32	32	32	32
Amps: average and per-phase, calculated neutral current	■	■	■	■
Voltage: V L-N, V L-L, average, per-phase	■	■	■	■
Power factor: average and per-phase	■	■	■	■
Frequency: any available phase	■	■	■	■
Revolutions per minute (RPM)	■	■	■	■
Phase angle : Amp Deg (V to Amps, per-phase)	■	■	■	■
% Unbalance: Maximum of 3-ph V and Amps	■	■	■	■
Life time counter - meter ON Hrs and number of power interruptions	■	■	■	■
Communication: RS-485, Modbus RTU protocol		■	■	■
Commercial reference number	METSEDM6000HCL10NC	METSEDM6200HCL10RS	METSEDM6220HCL1	METSEDM6220HCL1LVD

DM6xx0H

DM6xx0H series	
Mechanical characteristics	
Weight	~ 300 g (10.6 oz)
IP degree of protection	IP 51 front side, IP 30 meter body, tested as per IEC 60529 (IP 54 with optional gasket METSEIP54GK96X96FF or upgrade to IP65 front side with Optional accessory kit METSEIP65OP96X96FF)
Material	Polycarbonate meets UL 94V-0 flammability rating
Dimensions W x H x D	96 x 96 x 49 mm (3.78 x 3.78 x 1.93 in) maximum depth of the meter from housing mounting flange and 13 mm (0.51 in) protrusion of meter from housing flange
Mounting position	Vertical
Panel thickness	5 mm (0.196 in) maximum
Environmental characteristics	
Operating temperature	-10 to 60 °C (14 to 140 °F)
Storage temperature	-20 to 70 °C (-4 to 158 °F)
Humidity rating	5 to 95 % RH non-condensing
Pollution degree	2
Altitude	≤2000 m (6562 ft) Category III
Product life	>7 years
Insulation category	Double insulation for user accessible parts
Electromagnetic compatibility (tested as per IEC 61326-1)	
Electrostatic discharge	IEC 61000-4-2
Immunity to radiated field	IEC 61000-4-3
Immunity to fast transients	IEC 61000-4-4
Immunity to impulse waves	IEC 61000-4-5
Conducted immunity	IEC 61000-4-6
Immunity to magnetic fields	IEC 61000-4-8
Immunity to voltage dips	IEC 61000-4-11
Emissions	Emissions FCC Part 15 Class A/CE
Safety	
Europe	CE, as per IEC 61010-1 edition 3
US and Canada	cULus as per UL61010-1 and CAN/CSA-C22.2 IEC 61010-1 edition 3, for 480 V AC L-L
Measurement Category (Voltage inputs)	CAT III up to 480 V L-L
Overvoltage Category (Control power)	CAT III up to 300 V L-N
Dielectric	As per IEC/UL 61010-1 edition 3
Protective Class	II, Double insulated for user accessible parts
Green premium	EOL, REACH, PEP, RoHS complied
Other certification	RCM & EAC for Russia
Communication	
RS-485 port	Modbus RTU: 2-Wires, with ground & shield, 4800, 9600, 19200 or 38400 baud, Parity - Even, Odd, None, 1 stop bit if parity is Odd or Even, 2 stop bits if None DLF3000: Firmware update through communication port
Isolation	2.5 kV RMS, double insulated
Protection features	User configurable password (selectable from 0000 to 9999) protected for set-up
Display language	English
Technical publication	Printed installation guide (QSG) supplied with meter in multi-language (EN, ES, FR, DE, PT, RU, TR, ZH) and user guide in soft format
Human machine interface	
Display type - LED	8 segment Alpha-numeric LED, ~ 14.2 mm (0.55 in) height, 3 rows with 4 digits per row, 1 column of 12 LEDs to indicate percentage of load connected in system. 4 digits for VAF PF parameters with auto scrolling and auto range
Display type - LCD	Fast in-line view, three parameters name and value at one glance. 3+1 digits for instantaneous parameters and 5+3 digits for energy parameters with auto scale and auto range
Keypad	4 buttons for navigation at the front, combination of 2 buttons for lock/unlocking of commonly viewed page
Communications activity	Green LED (for indicating RS-485 interface or heartbeat pulse)

DM6xx0H

DM6xx0H VAF PF meter installation

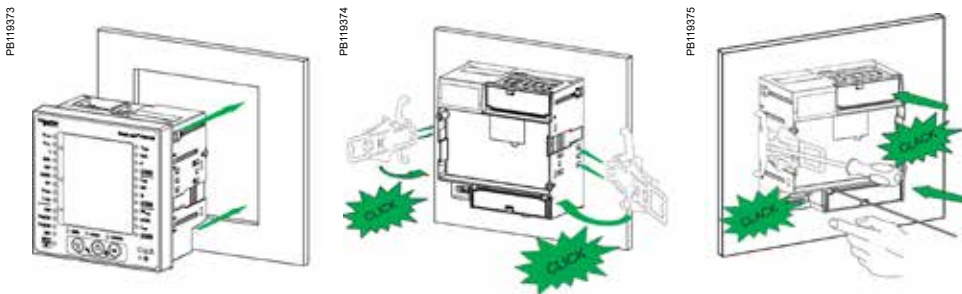

DM6xx0H VAF PF meter mechanical dimensions

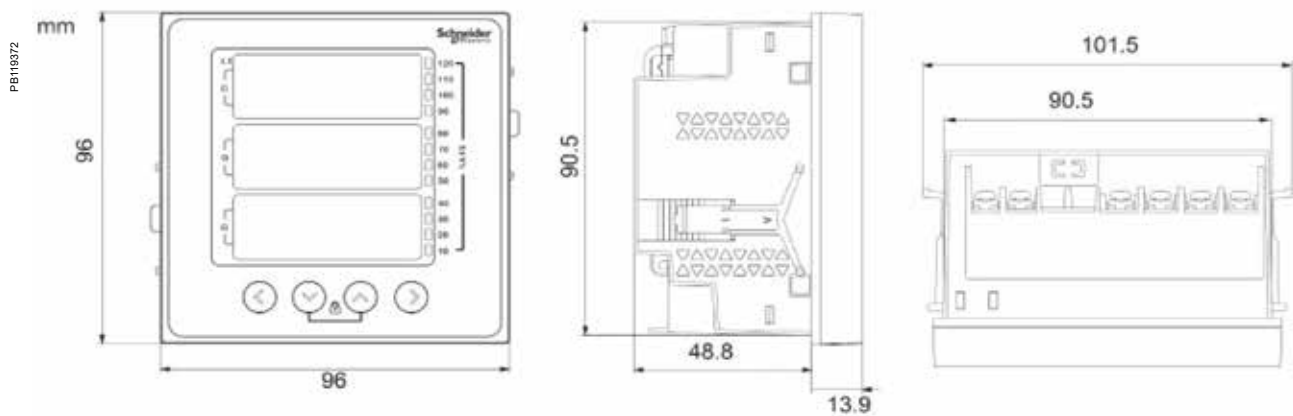

DM6xx0H series VAF PF meter display overview

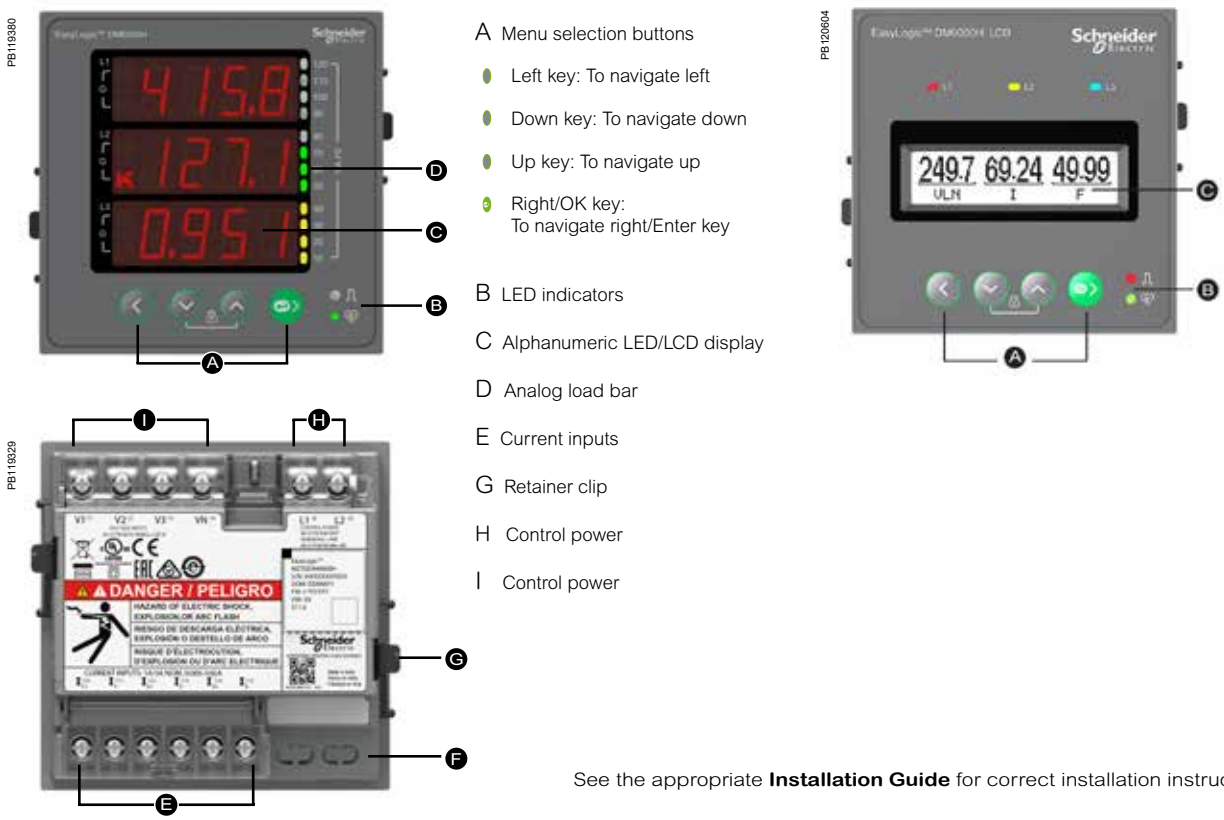

See the appropriate **Installation Guide** for correct installation instructions.

EasyLogic™ PM1000H series

The EasyLogic™ PM1000H basic power and energy meters

Offering all the measurement capabilities required to monitor the electrical installation in a single 96 x 96 mm unit, with 8 segment alphanumeric bright, large 14.2 mm high LED display (PM1125H) or with 128 * 32 pixels LCD display (PM1225H) options.



PM1000H



EasyLogic™ PM1225H power meter LCD display



EasyLogic™ PM1125H front view LED display



EasyLogic™ PM1000H power meter rear view

EasyLogic™ PM1125H/PM1225H meters are ideal replacements for multiple analog meters for stand-alone metering in custom panels, switch boards, switch-gear, genset panels, motor control centres, power factor improvement panels and OEM panel board.

• Application

- Cost management applications
 - Measurement of basic electrical parameters in control panels, motor control panels, power distribution boards, OEM's, Building management systems, panel instrumentation
 - Aggregation of energy consumption and cost allocation per area, per usage, per shift and per time within the same facility
- Network management applications
 - Power quality analysis (THD %)
 - Demand measurement
 - Measurement of Power factor
 - Phase angle between the voltage and current
 - % unbalance among voltage and current
 - Modbus RTU protocol RS-485 communication port for integration with energy management system

• Main characteristics

- Easy to install: Mounts using two retainer clips, no tools required. Compact meter with 49 mm meter depth behind the panel, connectable up to 480 V +10% AC volts L-L without voltage transformers for installation complaint with measurement category III, and double insulated.
- Easy to operate: Intuitive navigation with self-guided menus and Heart beat LED indicates normal functioning of meters while it conveys the communication status when connected to RS-485 network.
- LED display: Intuitive navigation with self-guided, four buttons, 8 segment alphanumeric LEDs of height ~14.2 mm (0.55 in), and three lines of concurrent values with Kilo & Mega value indicators.
- LCD display: Elegant single row, bright back lit graphical LCD display 132 * 32 pixels, Fast in-line view, three parameters name and value at one glance.
- Power and energy: measurement, display and recording of three power and corresponding energy parameters simultaneously - W/Wh, VA/ VAh and VAR/ VARh.
- Demand: measurement of Peak, present and last demand values of either W, VA or VAR parameters with selectable demand parameter, demand interval and demand technique.
- Accuracy:
 - Class 1.0 for active energy as per the test limits given in IEC 62053-21
 - Class 0.5 for active energy as per the test limits given in IEC 62053-22
 - Class 2.0 for reactive energy as per the test limits given in IEC 62053-23
 - Tested in accordance with IEC 62052-11 for energy test requirements
 - EMI/ EMC tests: As per IEC 61326-1
- CT nominal: 5 A or 1 A I-nominal (field settable). CT reversal auto correction for energy consumption.
- Password: Field configurable password for securing set up information and prevents tampering of integrated values.
- Cyber security: Option for disabling RS-485 port through front panel keys against unauthorized access. This feature can also be used for maintenance and troubleshooting of complex communication network.
- LED & LCD display: 4 digits for instantaneous parameters and 5+3 digits for energy parameters with auto scaling and auto range capability.
- Analog load bar in LED display type: The colour-coded analog load bar at the front side indicates the percentage of load through 12 LED's with the option to select full scale based on connected load.
- Suppression current: To disregard the measurement of induced and panel auxiliary load current in the circuit (settable from 5 to 99 mA).
- Protective cover: Tamper-proof terminal screws do not detach from housing.
- Control power options: Universal range 44 to 300V LN AC/DC or Low voltage DC control power option of 9 to 36V DC.
- Smart line indicators in LCD display meter: Helps check the presence of input supply voltage (healthy phase).

PM1000H technical specifications

General	
Use on LV & MV systems with Potential transformer (PT or VT)/ Current transformer (CT) ratio programmable at site	
Digital panel meters for measurement of basic electrical parameters	
Instantaneous rms values	
Current	Average line current of 3-phase, per-phase, and calculated neutral current
Voltage	Average voltage of L-L, L-N parameters, per-phase
Frequency	Any available line
Real (active), reactive, and apparent power	Total and per-phase
True power factor	Average and per-phase signed
% Unbalance	Maximum % unbalance among phases for Volts & Amps
Revolution per minute (RPM)	RPM of alternator or generator when number of poles set for 2, 4, 6, 8, 12, 14 or 16 (any one pole)
Energy values stored in non-volatile memory	
Delivered & Received or Forward & Reverse or Import & Export energy (4 quadrant) - Accumulated or Integrated active (Real - Wh), reactive (VARh), apparent (VAh).	
Interdependent energy (Wh) counter with non-resettable feature.	
Energy values can be set for overflow units (e.g., in kilo or mega scale)	
Quadrant based registers for Reactive energy	
Time counters such as meter ON Hrs, load RUN Hrs and power outage counters	
Old registers facilitate retrieval of last cleared energy values and load Run Hrs. Set up counters for tracking number of edits carried out since from installation	
Display	
LED display: Bright red colour, 8 segment alphanumeric LED, ~ 14.2 mm (0.55 in) height, 3 rows with 4 digits per row, auto range, auto scale	
LCD display: Elegant single row, bright back lit graphical LCD display 132 (Horizontal) * 32 (Vertical) pixels. Fast in-line view, three parameters name and value at	
Communication	
RS-485 serial channel connection Industry standard Modbus RTU protocol	
Native Plug and Play support for Schneider Electric energy management system software - EcoStruxure Power Monitoring Expert, EcoStruxure Power SCADA Operation along with ION Setup programming support	
Diagnostics	
Diagnostic page indicates the healthiness of communication system, device serial number, device model number OS & RS version, communication status, All LED segment check in LED display. In LCD display meter - alternate pixels ON/ OFF test. LCD contrast level, set back-lit time out in the range of 1 to 99 seconds	
Page lock	
Page lock and unlock features. Once the commonly referred page is enabled for lock feature, then the display returns to locked page in 4 minutes of inactive time	
Favourite page	
Number and type of parameters can be chosen and arranged in Favourite page according to the user's requirement	
Electrical characteristics	
Type of measurement	True RMS, 4 quadrant power and energy, 32 samples/ cycle
Measurement accuracy	
Current, per-phase & average	± 0.5 % of reading
Voltage, L-N, L-L, per-phase & average	± 0.5 % of reading
Power (active and apparent)	± 1.0 % for Class 1.0, ± 0.5% for Class 0.5
Power (reactive)	± 2.0 % for Class 1.0 & Class 0.5
Power factor, per-phase & average	± 0.01 of reading
Frequency	± 0.05 % for F-nominal 50/ 60 Hz ± 2 ± 0.2 % for Frequency range from 30 to 48 Hz, 52 to 58 Hz and 62 to 70 Hz
Active or real energy	Class 1.0 (± 1.0 %) Class 0.5 (± 0.5%)
Apparent energy	± 1.0 % & ± 0.5 %
Reactive energy	Class 2.0 (± 2.0 %)
THD %	± 5 % of reading
Input-voltage	
VT (PT) connection	Selectable from No VT (direct), 1 VT, 2 VT to 3 VT
VT (PT) primary	100 V L-L to 999 kV L-L max
U (V) nominal (secondary)	Up to 277 V L-N/ 480 V L-L (selectable VT secondary from 100, 110, 115, 120 to 415 V L-L)
Operating voltage range with accuracy	80-480 V L-L ± 10 % Category III
Measured Voltage with full range	35 to 600 V L-L
Permanent overload (withstand)	750 V L-L, continuous
Impedance	≥5 MΩ
Frequency range	50/ 60 Hz ± 2
VA burden	≤0.2 VA at 240 V L-N at 50 Hz
Frequency – measurement	
Nominal operating range	50/60 Hz ± 2 (± 0.05 % accuracy)
Extended operating range	30 to 48 Hz, 52 to 58 Hz and 62 to 70 Hz (± 0.2 % accuracy)
Voltage input	80 to 480 V L-L ± 10 %

PM1000H

PM1000H technical specifications (continued)

Input-current	
CT connect	Solo or multi-phase current measurement by installing CT (s) in either of A1, A2, A3, A12, A23, A13, A123 phase(s)
CT primary	1 A to 32767 Amps, programmable
CT secondary	1 A or 5 Amps I-nominal (field settable)
Operating current range with accuracy	10 mA to 6 A ⁺¹
Measured Amps with full range	5 mA to 10 A
Suppression current	5 to 99 mA (to disregard negligible load)
Permanent overload (withstand)	Continuous 10 A, 10 s/hr 50 A, 1s/hr 500 A
Impedance	0.3 mΩ
Frequency range	50/60 Hz ± 2
VA burden	≤0.1 VA at 5 A, 50 Hz
AC - control power	
Operating range	48 to 277 V DC ± 10 % or LVDC option of 9 to 36 V DC
Burden	≤4 VA at 240 V L-N, 50 Hz
Frequency	50/60 Hz nominal (45 to 65 Hz operating range)
Ride-through time	200 ms at 240 V L-N, 50Hz
DC - control power	
Operating range	48 to 277 V DC ± 10 %
Burden	≤2 W at 240 V DC
Ride-through time	120 ms at 240 V DC
Display update	
Instantaneous/ RMS parameters	1 s
Demand parameters	5 s
THD % (voltage and current)	5 s
Power system	
Phase labelling	Configurable to 123, ABC, rst, pqr or ryb
Wiring configuration	13 wiring schemes (5 on front screen) 1ph, 2 w, L-N 1ph, 2 w, L-L 1ph, 3 w, L-L with N (2phase) 3ph, 3 w, Delta, Ungrounded 3ph, 3 w, Delta, Corner Grounded ⁺² 3ph, 3 w, Wye, Ungrounded ⁺² 3ph, 3 w, Wye Grounded ⁺² 3ph, 3 w, Wye, Resistance Grounded ⁺² 3ph, 4 w, Open Delta, Center-Tapped ⁺² 3ph, 4 w, Delta, Center-Tapped ⁺² 3ph, 4 w, Wye, Ungrounded ⁺² 3ph, 4 w, Wye Grounded 3ph, 4 w, Wye, Resistance Grounded ⁺²
Mechanical characteristics	
Weight	~ 300 g (10.6 oz)
IP degree of protection	IP 51 front side, IP 30-meter body, tested as per IEC 60529 (IP 54 with optional gasket METSEIP54GK96X96FF or upgrade to IP65 front side with Optional accessory kit METSEIP65OP96X96FF)
Material	Polycarbonate meets UL 94V-0 flammability rating
Dimensions W x H x D	96 x 96 x 49 mm (3.78 x 3.78 x 1.93 in) (D = depth of the meter from housing mounting flange) 13 mm (0.51 in) protrusion of meter from housing flange
Mounting position	vertical
Panel thickness	5 mm (0.196 in) maximum
Environmental characteristics	
Operating temperature	- 10 to +60° C (14 to 140° F)
Storage temperature	- 20 to +70° C (-4 to 158° F)
Humidity rating	5 % to 95 % RH non-condensing
Pollution degree	2
Attitude	≤2000 metres (6562 ft), Category III
Product life	>7 years

⁺¹ Additional error of ± 2 % between 10 mA to 50 mA, ± 1% between 50 mA to 100 mA)

⁺² Through communication

PM1000H

PM1000H technical specifications (continued)

Electromagnetic compatibility (tested as per IEC 61326-1)	
Electrostatic discharge	IEC 61000-4-2
Immunity to radiated field	IEC 61000-4-3
Immunity to fast transients	IEC 61000-4-4
Immunity to impulse waves	IEC 61000-4-5
Conducted immunity	IEC 61000-4-6
Immunity to magnetic fields	IEC 61000-4-8
Immunity to voltage dips	IEC 61000-4-11
Emissions	Emissions FCC Part 15 Class A/CE
Safety	
Europe	CE, as per IEC 61010-1 edition-3
US and Canada	cULus as per UL61010-1 and CAN/CSA-C22.2 IEC 61010-1 edition-3, for 480 V AC L-L
Measurement Category (Voltage inputs)	CAT III up to 480 V L-L
Overvoltage Category (Control power)	CAT III up to 300 V L-N
Dielectric	As per IEC/UL 61010-1 edition-3
Protective Class	II, Double insulated for user accessible parts
Green premium	EOL, REACH, PEP, RoHS complied
Communication	
RS-485 port	Modbus RTU: 2-Wires, 4800, 9600, 19200 or 38400 baud, Parity - Even, Odd, None, 1 stop bit if parity is Odd or Even, 2 stop bits if none. DLF3000: Firmware update through communication port
Isolation	2.5 kV RMS, double insulated
Protection features	User configurable password (selectable from 0000 to 9999) protected for set-up and clearing of energy, and other integrated data
Display language	English
Technical publication	Printed installation guide (QSG) supplied with meter in multi-language (EN, ES, FR, DE, PT, RU, TR, ZH) and user guide in soft format
Human machine interface	
Display type	LED display: 8 segment Alpha-numeric LED, ~ 14.2 mm (0.55 in) height, 3 rows with 4 digits per row, 1 column of 12 LEDs to indicate percentage of load connected in system. 4 digits for instantaneous parameters with auto scaling and auto range LCD display: Fast in-line view, three parameters name and value at one glance. 3+1 digits for instantaneous parameters and 5+3 digits for energy parameters with auto scale and auto range scaling and auto range
Keypad	4 buttons for navigation at the front, combination of 2 buttons for performing set-up, lock/unlock pages and viewing diagnostic pages
CAL LED (pulse LED)	Red colour, meter constant is configurable from 1 to 9999000 pulses/ k_h (kWh, kVAh, or kVARh)
Comm. activity	Green LED (for indicating RS-485 interface or heart beat pulse)

Feature set summary

Parameter/ Meter reference	PM1125H	PM1225H	PM1120H*
Class of accuracy	1.0 / 0.5	1.0 / 0.5	1.0 / 0.5
Sampling rate per cycle	32	32	32
Amps: average and per-phase, calculated neutral current	■	■	■
Voltage: V L-N, V L-L, average, per-phase	■	■	■
Power factor: average and per-phase	■	■	■
Frequency: any available phase	■	■	■
Power (W, VA, VAR) - Total and per-phase	■	■	■
Energy (Wh, VARh, VAh) - Delivered & Received	■	■	■ 1 energy (Del only)
Demand parameters – selectable for W, VA, VAR (one at a time)	■	■	■
Old registers – retrieval of last cleared values of energy and Run Hrs	■	■	■
Revolutions per minute (RPM)	■	■	■
Phase angle : Amp Deg (V to Amps, per-phase)	■	■	■
% Unbalance: Max unbalance Volts & Amps among 3 phase (s)	■	■	■
Life time counter - meter ON Hrs, Load Run Hrs, number of power interruptions	■	■	■
Communication: 2 wire, RS-485, Modbus RTU protocol	■	■	■
Commercial reference numbers			
Commercial reference for 44 - 300 V AC/DC control power	METSEPM1125HCL10RS (CI 1.0) METSEPM1125HCL05RD (CI 0.5)	METSEPM1225HCL1 (CI 1.0) METSEPM1225HCL5 (CI 0.5)	METSEPM1120HCL10RS (CI 1.0) METSEPM1120HCL05RS (CI 0.5)
Commercial reference for Low Voltage DC (9-36 V) option	METSEPM1125HCL1LVD (CI 1.0) METSEPM1125HCL5LVD (CI 0.5)	METSEPM1225HCL1LVD (CI 1.0) METSEPM1225HCL5LVD (CI 0.5)	

* In PM1120H, measurement and display of any one power parameter at a time - configurable through set-up/ communication Energy measurement depends on type of power parameter selected during set up (W/Wh or VA/VAh or VAR/VARh). For reactive energy (VARh), total or net VARh on display, + VARh and - VARh through communication.

PM1000H

PM1000H meter mounting

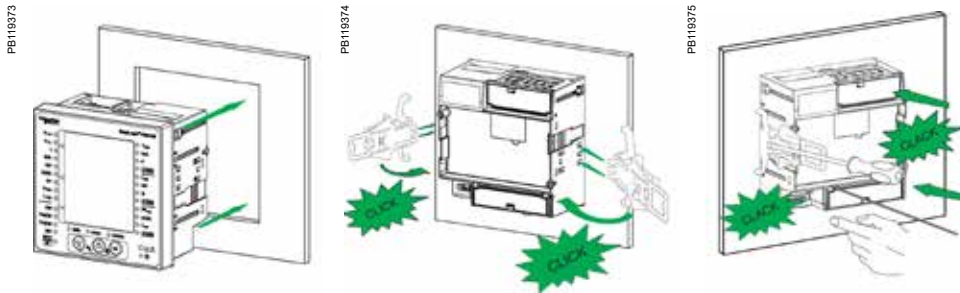

See the appropriate **Installation Guide** for correct installation instructions.

PM1000H meter mechanical dimensions

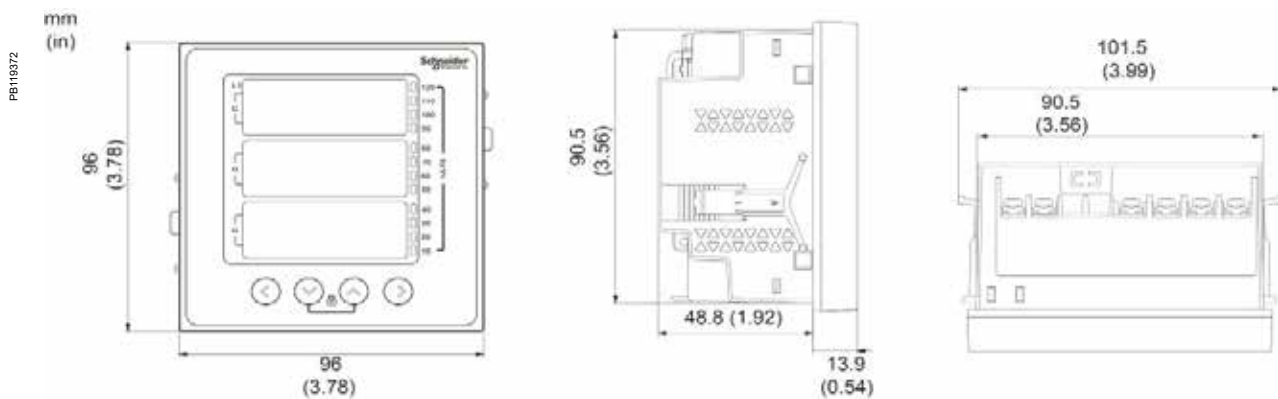

PM1000H LED/LCD meter displays overview

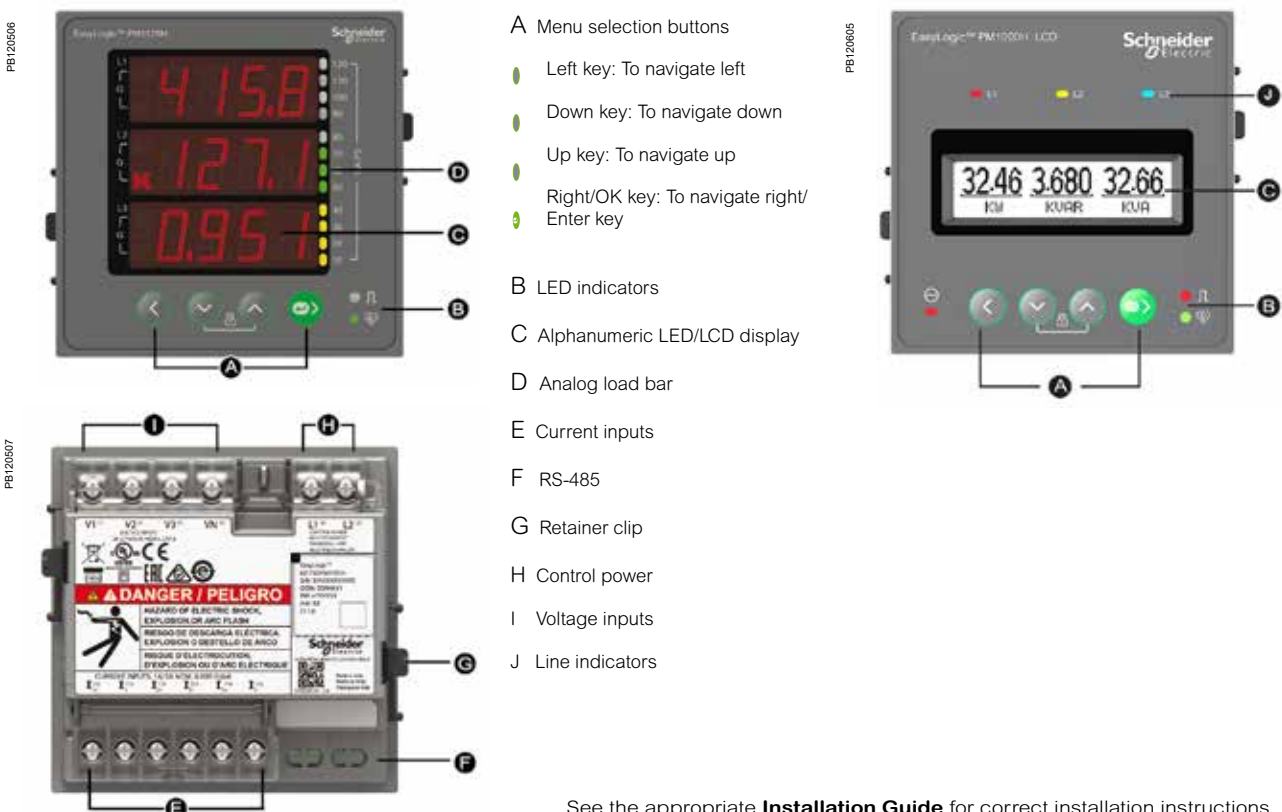

- A Menu selection buttons
 - Left key: To navigate left
 - Down key: To navigate down
 - Up key: To navigate up
 - Right/OK key: To navigate right/Enter key
- B LED indicators
- C Alphanumeric LED/LCD display
- D Analog load bar
- E Current inputs
- F RS-485
- G Retainer clip
- H Control power
- I Voltage inputs
- J Line indicators

See the appropriate **Installation Guide** for correct installation instructions.

The EasyLogic™ PM1130H/ PM1230H dual/alternate source power and energy meters

Two energy registers (Utility vs Genset, Utility vs Solar, Utility vs Wind, or a combination of any two power sources) separately records consumption for dual source energy accounting. Ideal for any installation which requires split energy monitoring for two conditions, e.g., running and Idle. Form A relay to control the load in the event of abnormality in the electrical circuit including excess consumption of power. The meters can be used for secondary billing application in large commercial complexes or buildings as tenant meters in custom panels, switch boards, switchgear, genset panels, non-renewable energy panel and OEM panel board.

Offering all the measurement capabilities required to monitor the electrical installation in a single 96 x 96 mm unit, PM1130H with 8 segment alpha-numeric bright, large 14.2 mm high LED display.

PM1230H meter displays measured parameters and values in elegant single row, bright back lit graphical LCD display in 128 * 32 pixels size.



PB119318

PB120545

PM1130H/ PM1230H

PB110316



EasyLogic™ PM1130H dual source meter front view

PB110328



EasyLogic™ PM1130H dual source meter rear view

PB120547



EasyLogic™ PM1000H meter LCD display

• Applications

- Cost management applications
 - Measure basic electrical parameters in control panels, power distribution boards, OEM's, and Building management systems
 - Aggregate energy consumption and cost allocation based on consumption from Utility vs Genset, or between any two power sources, per area, per shift and per time within the same facility
- Network management applications
 - Power quality analysis (THD %)
 - Demand measurement
 - Measurement of Power factor
 - Phase angle between the voltage and current
 - % unbalance among voltage and current
 - Modbus RTU protocol RS-485 port for integration with energy management system

• Main characteristics

- Easy to install: two retainer clips, no tools required. Compact meter with 49 mm meter depth behind the panel, connectable up to 480 V +10 % AC V L-L without voltage transformers for installation compliant with measurement category III, and double insulated
- Easy to operate: Intuitive navigation with self-guided menus and heartbeat LED indicates normal functioning of meters while it conveys the communication status when connected to RS-485 network
- LED display: Intuitive navigation, four buttons, 8 segment alpha-numeric LEDs and three lines of concurrent values with Kilo & Mega value indicator
- LCD display: Elegant single row, bright back lit graphical LCD display 128 * 32 pixels; fast in-line view, three parameters name and value at one glance
- Power and energy: measurement, display and recording of any one power and energy from source 1 and source 2 at a time (W/ Wh or VA/ VAh or VAR/ VARh – selectable through panel button or configuration software)
- Demand: measure Peak demand with occurrence time in counter, time remaining to complete demand cycle, present cycle and last cycle demand values. One demand parameter selectable - either W, VA or VAR, with the option of changing demand interval and demand technique
- Standard compliance:
 - Class 0.5 for active energy as per IEC 62053-22
 - Class 2.0 for reactive energy as per IEC 62053-23
 - Tested in accordance with IEC 62052-11 for energy test requirements
 - EMI/ EMC tests: As per IEC 61326-1
- CT nominal: 5 A or 1 A I-nominal (field settable). CT reversal auto correction for energy consumption.
- Password: Field configurable password prevents tampering
- Cyber security: disable RS-485 port through front panel keys against unauthorized access, also useful for maintenance and troubleshooting
- Auto scaling, 4 digits for Instantaneous parameters and 5+3 digits for energy parameter with auto scale and auto range capability
- Analog load bar: colour-coded bar indicates percentage of load via 12 LED's with the option to select full scale based on connected load
- Suppression current: Meter can be set to disregard the measurement of induced/ auxiliary load current in the circuit (settable from 5 mA to 99 mA)
- Favourite page: User selectable parameters in favourite page
- Relay: Form A, 2 terminals mechanical relay for alarm, control or annunciation if parameters exceeds or recedes set limit. Also activated on decremental energy from the preset energy value.
- Alternate/dual source power sensor: supports multiple generator paralleling and bus coupler islanding schemes
- Tamper cover protects against tampering with voltage and current terminals
- Non-resettable energy counter to ensure integrity of energy readings

PM1130H/ PM1230H

PM1130H technical specifications

General	
Use on LV & MV systems with Potential transformer (PT or VT) / Current transformer (CT) ratio programmable at site	
Digital panel meters for measurement of basic electrical parameters	
Instantaneous rms values	
Current	Average line current of 3-phase, per-phase, and calculated neutral current
Voltage	Average voltage of L-L, L-N parameters, per-phase
Frequency	Any available line
Real (active), reactive, and apparent power	Total and per-phase
True power factor	Average and per-phase signed
% Unbalance	Maximum % unbalance among phases for Volts & Amps
Revolution per minute (RPM)	RPM of alternator or generator when number of poles set for 2, 4, 6, 8, 12, 14 or 16 (any one pole)
Energy values stored in non-volatile memory	
Energy delivered from power source no.1: Accumulated active (Real - Wh) or reactive (VARh) or apparent (VAh) energy with user programmable alpha-numeric name	
Energy delivered from power source no.2: Accumulated active (Real - Wh) or reactive (VARh) or apparent (VAh) energy with user programmable alpha-numeric name	
Time counters such as meter ON Hrs, load RUN Hrs for both source of power and power outage counters Old registers facilitate retrieval of last cleared energy values and load Run Hrs	
Display	
LED display: Bright red colour; 8 segment alpha-numeric LED, ~ 14.2 mm (0.55 in) height, 3 rows with 4 digits per row, auto range, auto scale	
LCD display: Elegant single row, bright back lit graphical LCD display 128 * 32 pixels, Fast in-line view, three parameters name and value at one glance	
Communication	
RS-485 serial	Channel connection Industry standard Modbus RTU protocol, Integration with any Modbus compatible SCADA / DCS / PMS / EMS / BAS / BMS software
Native Plug and Play support	Schneider Electric energy management system software - EcoStruxure™ Power Monitoring Expert, EcoStruxure™ Power SCADA Operation along with ION Setup programming support
Alternate or dual source sensor	For sensing the presence of alternate power source to measure and record energy in separate registers
Diagnostics	
Diagnostic page indicates the healthiness of communication system, all LED test, device serial number, device model number OS & RS version, communication status, error code display	
Page lock	
Page lock and unlock features. Once the commonly referred page is enabled for lock feature, then the display returns to locked page in 4 minutes of inactive time	
Favourite page	
Number and type of parameters can be chosen and arranged in Favourite page according to the user's requirement	
Relay	
Relay can be operated based on the set limits assigned for V L-L, V L-N, A, Hz, PF, Instantaneous power (W, VA, VAR), demand parameter (W, VA, VAR) Relay can also be programmed to activate based on decremental energy consumed in the system from the preset energy value	
Electrical characteristics	
Type of measurement	True RMS, 4 quadrant power and 2 quadrant energy, 32 samples/ cycle
Measurement accuracy	
Current, per-phase & average	± 0.5 % of reading
Voltage, L-N, L-L, per-phase & average	± 0.5 % of reading
Power (active and apparent)	± 0.5 % for Class 0.5
Power (reactive)	± 2.0 % for Class 0.5
Power factor, per-phase & average	± 0.01 of reading
Frequency	± 0.05 % for F-nominal 50/ 60 Hz ± 2 ± 0.2 % for Frequency range from 30 to 48 Hz, 52 to 58 Hz and 62 to 70 Hz
Active or real energy	Class 0.5 (± 0.5 %)
Apparent energy	± 0.5 %
Reactive energy	Class 2.0 (± 2.0 %)
THD %	± 5 % of reading
Input-voltage	
VT (PT) connection	Selectable from No VT (direct), 1 VT, 2 VT to 3 VT
VT (PT) primary	100 V L-L to 999 kV L-L max
U (V) nominal (secondary)	Up to 277 V L-N/ 480 V L-L (selectable VT secondary from 100, 110, 115, 120 to 415 V L-L)
Operating voltage range with accuracy	80-480 V L-L ± 10 % Category III
Measured Voltage with full range	35 to 600 V L-L
Permanent overload (withstand)	750 V L-L, continuous
Impedance	≥ 5 MΩ
Frequency range	50/60 Hz ± 2
VA burden	≤ 0.2 VA at 240 V L-N at 50 Hz

PM1130H/ PM1230H

Frequency – measurement	
Nominal operating range	50/60 Hz \pm 2 (\pm 0.05 % accuracy)
Extended operating range	30 to 48 Hz, 52 to 58 Hz and 62 to 70 Hz
Voltage input	80 to 480 V L-L \pm 10 %
Input-current	
CT connect	Solo or multi-phase current measurement by installing CT (s) in either of A1, A2, A3, A12, A23, A13, A123 phase(s)
CT primary	1 A to 32767 A programmable
CT secondary	1 A or 5 A I-nominal (field settable)
Operating current range with accuracy	10 mA to 6 A ⁺¹
Measured Amps with full range	5 mA to 10 A
Suppression current	5 to 99 mA (to disregard negligible load)
Permanent overload (withstand)	Continuous 10 A, 10s/hr 50 A, 1s/hr 500 A
Impedance	0.3 m Ω
Frequency range	50/ 60 Hz \pm 2
VA burden	\leq 0.1 VA at 5A, 50 Hz
AC - control power	
Operating range	60 to 277 V L-N AC \pm 10 %
Burden	\leq 6 V A at 240 V L-N, 50 Hz
Frequency	50/ 60 Hz nominal (45 to 65 Hz operating range)
Ride-through time	120 ms at 240 V L-N, 50Hz
DC - control power	
Operating range	60 to 277 V L-N DC \pm 10 %. Low voltage DC control power option of 9 to 36V DC is available in PM1230H
Burden	\leq 3 W at 240 V DC
Ride-through time	120 ms at 240 V DC
Display update	
Instantaneous/ RMS parameters	1 s
Demand parameters	5 s
THD % (voltage and current)	5 s
Power system	
Phase labelling	Configurable to 123, ABC, rst, pqr or ryb
Energy source labelling – one letter programmable	alpha-numeric, A to Y (except X), or 0 to 9
Wiring configuration	13 wiring schemes (5 on front screen) 1ph, 2 w, LN 1ph, 2 w, LL 1ph, 3 w, LL with N (2-phase) 3ph, 3 w, Delta, Ungrounded 3ph, 3 w, Delta, Corner Grounded ⁺² 3ph, 3 w, Wye, Ungrounded ⁺² 3ph, 3 w, Wye Grounded ⁺² 3ph, 3 w, Wye, Resistance Grounded ⁺² 3ph, 4 w, Open Delta, Center-Tapped ⁺² 3ph, 4 w, Delta, Center-Tapped ⁺² 3ph, 4 w, Wye, Ungrounded ⁺² 3ph, 4 w, Wye Grounded 3ph, 4 w, Wye, Resistance Grounded ⁺²
Mechanical characteristics	
Weight	\sim 300 g (10.6 oz)
IP degree of protection	IP 51 front side, IP 30-meter body, tested as per IEC 60529 (IP 54 with gasket METSEIP54GK96X96FF or upgrade to IP65 front side with Optional accessory kit METSEIP65OP96X96FF)
Material	Polycarbonate meets UL 94V-0 flammability rating
Dimensions W x H x D	96 x 96 x 52 mm (3.78 x 3.78 x 2.05 in) (D = depth of the meter from housing mounting flange) 13 mm (0.51 in) protrusion of meter from housing flange
Mounting position	vertical
Panel thickness	5 mm (0.196 in) maximum
Environmental characteristics	
Operating temperature	- 10 to +60° C (+14 to +140° F)
Storage temperature	- 20 to +70° C (-4 to +158° F)
Humidity rating	5 to 95 % RH non-condensing
Pollution degree	2
Attitude	\leq 2000 metres (6561 ft), Category III
Product life	>7 years
Insulation category	Double insulation for user accessible parts

⁺¹ Additional error of \pm 2 % between 10 mA to 50 mA, \pm 1 % between 50 mA to 100 mA

⁺² Through Communication

PM1130H/ PM1230H

Electromagnetic compatibility (tested as per IEC 61326-1)		
Electrostatic discharge	IEC 61000-4-2	
Immunity to radiated field	IEC 61000-4-3	
Immunity to fast transients	IEC 61000-4-4	
Immunity to impulse waves	IEC 61000-4-5	
Conducted immunity	IEC 61000-4-6	
Immunity to magnetic fields	IEC 61000-4-8	
Immunity to voltage dips	IEC 61000-4-11	
Emissions	Emissions FCC Part 15 Class A/CE	
Safety		
Europe	CE, as per IEC 61010-1 edition-3	
US and Canada	cULus as per UL61010-1 and CAN/CSA-C22.2 IEC 61010-1 edition-3, for 480 V AC L-L	
Measurement Category (Voltage inputs)	CAT III up to 480 V L-L	
Overvoltage Category (Control power)	CAT III up to 300 V L-N	
Dielectric	As per IEC/UL 61010-1 edition-3	
Protective Class	II, Double insulated for user accessible parts	
Green premium	EOL, REACH, PEP, RoHS complied	
Other certification	RCM & EAC for Russia	
Communication		
RS-485 port	Modbus RTU: 2-Wires, 4800, 9600, 19200 or 38400 baud, Parity - Even, Odd, None, 1 stop bit if parity is Odd or Even, 2 stop bits if none.	
Alternate or dual source sensor	2 pin connector, suitable for pair of 1.5 sq mm multi-strand or single strand cable AC: 80 – 277 V $\pm 10\%$ ON status, 0 to 30 V OFF status DC: 18 – 60 V $\pm 10\%$ ON status, 0 to 4 V OFF status	
Relay output	Form A relay, 2 pin terminals, 300 V L-N AC max. / 2 A; 24 V DC / 2 A	
Isolation	2.5 kV RMS, double insulated	
Protection features	User configurable password (selectable from 0000 to 9999) protected for set-up and clearing of energy, and other integrated data	
Display language	English	
Technical publication	Printed installation guide (QSG) supplied with meter in multi-language (EN, ES, FR, DE, PT, RU, TR, ZH) and user guide in soft format	
Human machine interface		
Display types	LED display: 8 segment alphanumeric, ~ 14.2 mm (0.55 in) height, 3 rows with 4 digits per row, 1 column of 12 LEDs to indicate percentage of load connected in system. 4 digits for instantaneous parameters and 5+3 digits for energy parameters with auto scrolling and auto range LCD display: Elegant single row, bright back lit graphical LCD display 128 * 32 pixels, Fast in-line view, three parameters name and value at one glance.	
Keypad	4 buttons for navigation at the front, combination of 2 buttons for lock/unlock pages	
CAL LED (pulse LED)	Red colour, meter constant is configurable from 1 to 9999000 pulses/ k_h (kWh, kVAh, or kVARh)	
Comm. activity	Green LED (for indicating RS-485 interface or heart beat pulse)	
Alternate or dual source LED	Red colour LED glows continuously during the presence of AC or DC voltage across the dual source sensor	
Feature set summary		
Parameter/ Meter reference	PM1130H	PM1230H
Accuracy Class of Wh (active energy)	0.5 ($\pm 0.5\%$)	1.0 ($\pm 1.0\%$)/ 0.5 ($\pm 0.5\%$)
Accuracy Class of VARh (reactive energy)	2.0 ($\pm 2.0\%$)	2.0 ($\pm 2.0\%$)
Accuracy Class of VAh (apparent energy)	$\pm 0.5\%$	$\pm 1.0\%$ / $\pm 0.5\%$
Sampling rate per cycle	32	32
Amps: average and per-phase, calculated neutral current	■	■
Voltage: V L-N, V L-L, average, per-phase	■	■
Power factor: average and per-phase	■	■
Frequency: any available phase	■	■
Power (W or VA or VAR – any one) Measurement and display of any one power parameter at a time, configurable through set-up/ communication	■	■
Energy - delivered or forward or import energy: Wh, VAh, VARh One energy measurement at a time	■	■
Demand parameters – selectable for W, VA, VAR (one at a time)	■	■
Old registers - retrieval of last cleared values of source 1 & source 2 energy, source 1 and source 2 Load Run Hrs Run Hrs	■	■
Revolutions per minute (RPM)	■	■
Phase angle : Amp Deg (V to Amps, per-phase)	■	■
% Unbalance: Maximum of 3-ph V and Amps	■	■
Life time counter - meter ON Hrs, source 1 Load Run Hrs, source 2 Load Run Hrs and number of power	■	■
Communication: 2 wire, RS-485, Modbus RTU protocol	■	■

PM1130H/ PM1230H

PM1130H dual source meter mounting

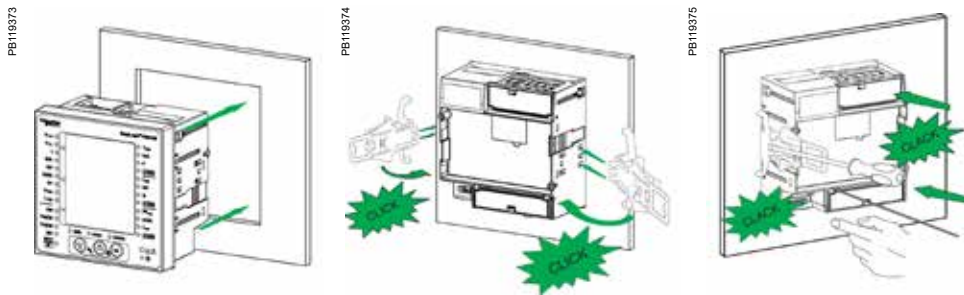

See the appropriate **Installation Guide** for correct installation instructions.

PM1130H dual source meter mechanical dimensions

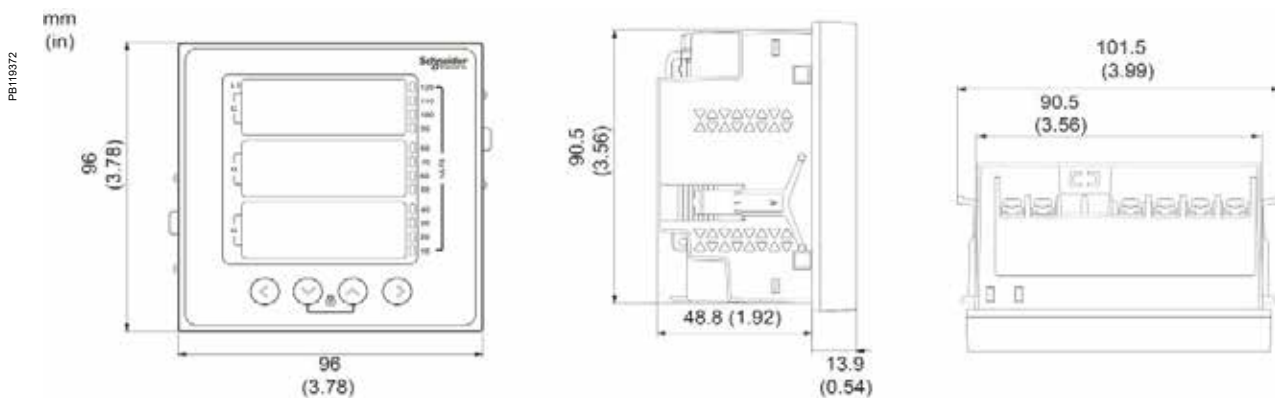

PM1130H series dual source meter display overview

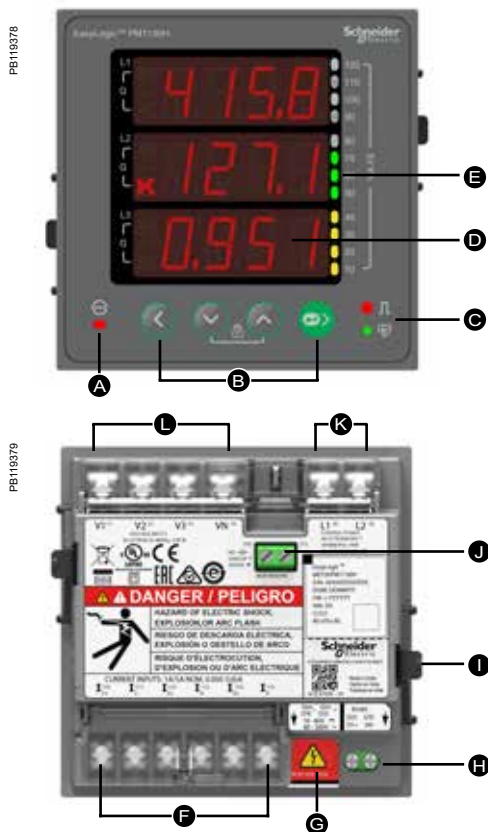

- A Dual source LED indicator
- B Menu selection buttons
 - ◀ Left key: To navigate left
 - ▼ Down key: To navigate down
 - ▲ Up key: To navigate up
 - ▶ Right/OK key: To navigate right/Enter key
- C LED indicators
 - Red: Pulse
 - Green: Heartbeat
- D Alpha numeric LED/ LCD display
- E Analog load bar
- F Current inputs
- G Alternate source (e.g. Genset)
- H RS-485
- I Retainer clip
- J Relay (PM1130H only)
- K Control power
- L Voltage inputs



See the appropriate **Installation Guide** for correct installation instructions.

EasyLogic

PM2000 series

The EasyLogic™ PM2000 multi-function power and energy meter

Offering all the measurement capabilities required to monitor and electrical installation in a single 96 x 96 mm unit, with LED or LCD display options.

Applications

Cost management applications

- Bill checking to verify that you are only charged for the energy you use
- Aggregation of energy consumption, including WAGES, and cost allocation per area, per usage, per shift or per time within the same facility
- Energy cost and usage analysis per zone, per usage or per time period to optimise energy usage

Network management applications

- Metering of electrical parameters to better understand the behaviour of your electrical distribution system
- Power quality analysis



PM2000



PM2100 series LED display meter



PM2000 LCD display

Introducing EasyLogic PM2000 series, next generation power meter which offers all the measurement capabilities required to monitor an electrical installation in a single 96 x 96 mm unit. PM2000 meters are available in LED and LCD display variants.

- PM2100 series:
 - LED display type: Intuitive navigation with self-guided, three buttons, bright red colour LEDs of 14.2 mm height. Two columns of LEDs indicate the parameter name chosen for display.
- PM2200 series:
 - LCD display type: Monochrome graphical LCD of 128 x 128 pixels lets users read all three phase values simultaneously. The bright display enables easy reading even in extreme lighting conditions and viewing angles. with intuitive menus, multi-language text, icons and graphics.
- Network management:
 - Power Quality analysis: THD % and individual harmonics to 15th and 31st order.
 - Measurement of True PF and Displacement PF.
 - Recording Min/Max values of instantaneous parameters with date and timestamp.
 - Optional IO modules comprising either 2 Digital Inputs and 2 Outputs, or 2 Analog Inputs and 2 Outputs for comprehensive WAGES monitoring.
 - Calculates % unbalance for voltage & current.
 - Embedded 2 D/I and 2 D/O in PM2125 and PM2225 meters.
- Main characteristics:
 - Easy to install: Mounts using two clips, no tools required. Compact 54 mm depth, connectable up to 480 ±10% AC Volts L-L without voltage transformers for installations compliant with measurement category III, and double insulated.
 - Easy to operate: Intuitive navigation with self-guided menus and LED for test and calibration on site or lab. Heartbeat LED indicates normal functioning and communication status if connected to RS-485 network.
 - Product standard compliance
 - Active energy Class 1.0 as per IEC 62053-21
 - Active energy Class 0.5S as per IEC 62053-22 (partial compliance for active energy test clause only)
 - Reactive energy Class 1.0 as per IEC 62053-24 (partial compliance for reactive energy test clause only)
 - Tested in accordance with IEC 62052-11 standard for
 - 5 A, I-nominal
 - 1 A, I-nominal (field settable).

Feature selection

Commercial ref. number	Model
METSEPM2110	PM2110
METSEPM2120	PM2120
METSEPM2125C2AI2AO	PM2125C ⁺¹
METSEPM2125C2DI2RO	PM2125C ⁺¹
METSEPM2130	PM2130
METSEPM2210	PM2210
METSEPM2220	PM2220
METSEPM2225C2AI2AO	PM2225C ⁺¹
METSEPM2225C2DI2RO	PM2225C ⁺¹
METSEPM2230	PM2230
METSEPM2KDGTLIO22	PM2K2DIDO
METSEPM2KANLGIO22	PM2K2AIAO
METSEPM2KANLGIO11	PM2K1AIAO

See your Schneider Electric representative for complete ordering information.

PM2000

- Main characteristics: (cont'd)
 - Power quality analysis: The PM2000 offers THD % measurements and Individual harmonics up to 15th order in PM2x20 and PM2x25C variants and up to 31st in PM2x30 variants.
 - Load management: Simultaneous display of peak, present, predicted & rising demands of all the four demand parameters (W, VA, VAR, Amps)
 - Billing: Tenant billing/utility meter cross check (where local regulations are not applicable).
 - Timer: Active load timer, Meter operation timer and Run hours timer. These features help advise maintenance requirements and scheduling.
 - Password: Field configurable password for securing set up information and prevent tampering of integrated values.
 - Cyber security: Option for disabling RS-485 port through front panel keys against unauthorized access. It helps during installation and trouble shooting of communication network.
 - LED display: Auto scaling, 9+3 digits for energy, 4 digits for other parameters.
 - LCD display: 5 digits for energy, 5 or 6 digits for other parameters, with auto scaling.
 - Daily time snap shot: Snap shot of Avg Voltage, Avg Current, Total Active Power & Energy delivered as measured by the meter at configurable time of day. The static page will be refreshed with new values at a configured time next day.
 - Rate counters: 2 configurable counters display values in custom specified units based on energy recorded (e.g., kgCO₂ carbon emission or energy cost).
 - Energy preset feature: Write the energy values during maintenance operation or replacement of meters. Configuration is through ION set up utility tool.
 - Auto reset: Monthly reset of all energies and max demand based on configurable day of the month at fixed 00 Hrs (PM2220, PM2230).
 - Suppression current: To disregard induced or negligible current flowing in the circuit, minimum value of current detection can be settable from 5 to 99 mA, default is 5 mA (all variants).
 - Retrofit register: Legacy modbus registers to read 50 parameters (meters with communication port).
 - Quadrant based VARh: Available through communication.
 - Multi-tariff energy - 4 multi tariff registers, can be activated through command, TOU or Input mode with Digital IO card. (PM2230).
 - Non-resettable energy (Del & Rec values of Wh, VARh, VAh) counter on display and communication that cannot be reset to zero (PM2210/20/30).
 - Configurable favorite page: Pick and configure any 4 parameters for display from the list of - V L-L, V L-N, Amps, F, W-tot, VA-tot, VAR-tot, PF and Wh-Del, VAh-Del, VARh-Del (PM2220, PM2230).
 - Whetting output voltage: Can be used for excitation of status input signal, available in PM2K2DIRO module

PM2000

PB114317



Rear of PM2000 closed

PB114318



Rear of PM2000 open

PB114321



Rear of PM2000 without I/O module

PM2000 technical specifications

General	
Use on LV and MV systems with onsite programmable PT/CT ratio	
Basic metering with THD %, Individual Harmonics, RTC and min/max readings	
Instantaneous rms values	
Current	Average line current of 3-phase, per-phase, and calculated neutral current
Voltage	Average voltage of L-L, L-N parameters, and per-phase
Frequency	Any available line
Real, reactive, and apparent power	Total and per-phase value
Displacement power factor	Average and per-phase signed, four quadrant
True Power Factor	Average and per-phase signed, four quadrant
% Unbalance	Among the phase for Amps, V L-N, V L-L
Energy values stored in non-volatile memory	
Four quadrant measurement for Delivered (Forward or Import) and Received (Reverse or Export) energy	Accumulated energy values for Active, Reactive & Apparent Energy parameters, quadrant basis Net & Total (absolute) values
Timer	Accumulated time counters for active load timer, meter operation timer, run hours and power outage counter
Old Registers	Facilitates retrieval of last cleared energy values
Demand values	
Current average	Present, Last, Predicted, Peak, and Peak Date Time
Active power	Present, Last, Predicted, Peak, and Peak Date Time
Reactive power	Present, Last, Predicted, Peak, and Peak Date Time
Apparent power	Present, Last, Predicted, Peak, and Peak Date Time
Demand sync methods	Thermal, Timed, Command Sync, and Clocked Sync
Demand calculation mode	Sliding, fixed and rolling block
Demand intervals	Settable from 1 to 60 minutes, in steps of 1 minute
Display	
PM2100 series	Bright red colour LED display, 7 segment LED, ~ 14.2 mm height, 3 rows with 4 digits per row, Auto range
PM2200 series	Full scape, monochrome graphical LCD of 128 x 128 pixels with viewable area of 67 x 62.5 mm
Visualization mode for signs	IEC or IEEE type in LCD display meter
Communication	
RS-485 serial	Channel connection Industry standard Modbus RTU protocol
Integration with software	SCADA / DCS / PMS / EMS / BAS / BMS software
Native Plug and Play support	Schneider Electric energy management system software - EcoStruxure™ Power Monitoring Expert, EcoStruxure PowerSCADA Operation, & ION Setup programming support
Min/Max values	
Minimum & Maximum value recording of 3-ph average or total	For 8 parameters, viz., V L-L, V L-N, Amps, PF, Hz, W, VA, VAR with date and time stamp, resettable separately through set up mode
Alarms	
Alarming with time stamping in PM2x30 meters	A different combination of set point driven alarms and digital alarms with 1 s time stamping. The alarms can be programmed and combined to trigger digital outputs, the meter keeps an alarm logs with the active and historical alarms with date and time stamping in 40 registers
Diagnostics	
Diagnostic page	Indicates LED/LCD status, sl number, diag pages, OS & RS version
Lock/ Un-Lock	
Page Lock & Unlock (PM2100 series)	Unique feature to ensures that commonly referred page is restored in 4 minutes of inactive time
Rate 1 counter ^{*2}	
kgCO ₂ emission (example)	Rate counter can be configured to display the CO ₂ emission in kgCO ₂ format based on the kWh measured either in delivered or received direction.
Rate 2 counter ^{*2}	
Tariff counter (example)	Rate counter can also be configured to calculate the electricity cost based on the energy consumption in customized currency format.
12am snap shot	
12am snap shot ^{*2}	Snap shot of Avg Voltage, Avg Current, Total Active Power & Energy delivered as measured by the meter at 12am. Static page is refreshed with new values by 12am next day.

*2 Available in PM2220/PM2230 (LCD) meters

PM2000

PM2000 electrical characteristics

PB114320



Rear of PM2000 with I/O module

PB114319



Rear of PM2000 with I/O module disconnected

Electrical characteristics	
Type of measurement	True RMS 64 samples per cycle
Measurement accuracy	
Current, average & per-phase	±0.5 %
Voltage average & per-phase	±0.5 %
Frequency	±0.05 %
Power Factor, average & per-phase	±0.01
Power (W-Active, VA- Apparent)	±0.5 %
Power (VAR- Reactive)	±1.0 %
Real/ Active Energy (Wh)	Class 0.5S as per IEC 62053-22 and Class 1.0 as per IEC 62053-21 for both CT nominal of 5 A and 1 A ⁺³
Reactive Energy	Class 1.0 as per IEC 62053-24
Apparent Energy	±0.5 %
THD % and Individual Harmonics- V & A	±5 % FS for THD % and Individual harmonics
Input-voltage	
VT primary	999 kV L-L max, secondary voltage depends on VT ratio
U nominal	277 V L-N/480V L-L
Measured V with full range	20-277 V L-N/35 - 480 V L-L, cat III 20-347 V L-N/35 - 600 V L-L, cat II
Permanent overload	750 V AC L-L
Impedance	=> 5 MΩ
Frequency nominal	50/60 Hz
VA burden	< 0.2 VA at 240 V AC L-N
Input-current	
CT ratings	Primary adjustable 1 A to 32768 A Secondary 1 A or 5 A I-nominal
Measured Amps with over range and Crest Factor	5 mA to 6 A
Over current withstand	Continuous 12 A, 10s/hr 50 A, 1s/hr 500 A
Impedance	< 0.3 mΩ
Frequency nominal	50/60 Hz
VA Burden	<0.024 VA at 6 A
AC control power	
Operating range	44- 277 V AC ±10% (80-277 V AC ±10% with I/O card)
Burden	<6 VA at 277 V AC L-N (<8 VA for PM2x30 and PM2x25C)
Frequency	45 to 65 Hz
Ride-through time	100 ms typical at 120 V AC and maximum burden (50 ms with Analog IO card for PM2x30) 400 ms typical at 230 V AC and maximum burden (50 ms with Analog IO card for PM2x30)
DC control power	
Operating range	48-277 V DC ±10% (100-277 V DC ±10% with I/O card)
Burden	< 2 W at 277 V DC (< 3.3 W for PM2x30 and PM2x25C)
Ride-through time	50 ms typical at 125 V DC and maximum burden
Real time clock	
RTC with battery backup	3 years (when meter is in Power OFF condition)
Displays update	
Instantaneous	1 s
Demand	15 s
Harmonics	5 s
Wiring configuration	
User programmable	1ph, 2w, L-N 1ph, 2w, L-L 1ph, 3w, L-L with N (2phase) 3ph, 3w, Delta, Ungrounded 3ph, 3w, Delta, Corner Grounded ⁺⁴ 3ph, 3w, Wye, Ungrounded ⁺⁴ 3ph, 3w, Wye Grounded ⁺⁴ 3ph, 3w, Wye, Resistance Grounded ⁺⁴ 3ph, 4w, Open Delta, Center-Tapped ⁺⁴ 3ph, 4w, Delta, Center-Tapped ⁺⁴ 3ph, 4w, Wye, Ungrounded ⁺⁴ 3ph, 4w, Wye Grounded 3ph, 4w, Wye, Resistance Grounded ⁺⁴

⁺³ For 1 A CT nominal, additional error of ±1 % from 50 mA to 150 mA, ±2 % for current > 10 mA to < 50 mA. Partial standard compliance for Class 0.5S meter type (energy test clause only)
⁺⁴ Through communication in PM2100 series meters

PM2000

PM2000 series mechanical characteristics

Mechanical characteristics

Weight	~ 300 gm
IP degree of protection	IP54 front side, IP30 meter body as per IEC 60529; upgrade to IP65 front side with Optional accessory kit METSEIP65OP96X96FF
Material	Polycarbonate meets UL 94V-0 flammability rating
Dimensions W x H x D	96 x 96 x 54 mm maximum (depth of the meter from housing mounting flange) and 13 mm (protrusion of meter from housing flange). Meter depth with IO module is 74 mm
Mounting position	Vertical
Panel thickness	5 mm maximum

Environmental characteristics

Operating temperature	Meter -10 to +60 °C (14 to 140 °F)
Storage temperature	Meter -25 to +70 °C (-13 to 158 °F)
Humidity rating	5 to 95 % RH non condensing
Pollution degree	2
Altitude	≤ 2000 m (6562 ft) Category III
Product life	Minimum 7 years

Electromagnetic compatibility (tested as per IEC 61326-1)

Electrostatic discharge	IEC 61000-4-2
Immunity to radiated field	IEC 61000-4-3
Immunity to fast transients	IEC 61000-4-4
Immunity to impulse waves	IEC 61000-4-5
Conducted immunity	IEC 61000-4-6
Immunity to magnetic fields	IEC 61000-4-8
Immunity to voltage dips	IEC 61000-4-11
Emissions	Emissions FCC Part 15 Class A/CE

Safety

Europe	CE, as per IEC 61010-1 Ed-3
US and Canada	cULus as per UL61010-1 and CAN/CSA-C22.2 No. 61010-1, for 600V AC
Measurement Category (Voltage and Current inputs)	CAT III up to 480 V L-L CAT II up to 600 V L-L
Overvoltage Category (Control power)	CAT III up to 300 V L-N
Dielectric	As per IEC/UL 61010-1 Ed-3
Protective Class	II, Double insulated for user accessible parts
Green premium	EOL, REACH, PEP, RoHS complied
Other certification	RCM (Australia), EAC (Russia)

Communication

RS-485 port	Modbus RTU: 2-Wires, with ground & shield, 4800, 9600, 19200 or 38400 baud, Parity - Even, Odd, None, 1 stop bit if parity is Odd or Even, 2 stop bits if None DLF3000: Firmware update through communication port
Pulse Output – POP	Max 40 V DC, 20 mA 20 ms ON time Configurable pulse weight from 1 to 9999000 pulses/k_h (kWh, kVAh, or kVARh)
Isolation	2.5 kV RMS, double insulated
Protection features	Password protected for set-up & clearing energy and Min/Max data
Display language	English, Spanish, French, Chinese, German, Portugese, Russian, Turkish
Technical publication	Printed installation guide (IG) with the meter in multi language (EN,ES,FR,DE,PT, RU,TR,ZH)

Human machine interface

Display type	LED display: 7 segment LED, ~ 14.2 mm height, 3 rows with 4 digits per row 2 columns of LEDs, one on each side of the LED panel to indicate the parameters under measurement LCD display: Monochrome graphical LCD of 128 x 128 pixels with viewable area of 67 x 62.5 mm
Keypad	PM2100 series: 3 buttons for navigation & combination of 2 buttons for performing set-up, Lock/unlocking of page, Diagnostic page operation PM2200 series: 4 buttons for intuitive navigation of HMI/ UI pages
CAL LED Indicator	Red colour, meter constant is configurable from 1 to 9999000 pulses/k_h (kWh, kVAh, or kVARh)
Comm. activity	Green LED (for indicating RS-485 interface or heart beat pulse)

PM2000



Rear of PM2200 with I/O module



Digital I/O module



Analog I/O module

PM2000 series electrical characteristics of IO modules

Status Inputs (Digital Inputs)	
Voltage ratings	18.5 to 36 V DC, OFF 0 to 4 V DC
Input resistance	110 k Ω
Max Frequency	2 Hz (T ON min = T OFF min = 250 ms)
Detect Time	20 ms
Update time	1 s
Isolation	2.5 kV RMS
Supported models	Available as default feature in PM2125/ PM2225 and Expandable option in PM2130/ PM2230 meter model
Application	Integration of Breaker status or other non-electrical devices like steam, water, gas meter through pulse inputs
Display support	Available on PM2230/PM2225 (LCD type). In PM2130/ PM2125 meter, data is available through communication only.
Set up and configuration	Through set-up software
Digital Outputs	
Voltage ratings	40 V DC max, 20mA max
On Resistance	50 Ω max
Meter constant	Configurable from 1 to 9999000 k _h (kWh, kVARh, kVAh)
Pulse width	20, 25, 50, 100 ms
Pulse frequency (typical)	25 Hz
Leakage current	1 micro Amps
Isolation	2.5 kV RMS
Supported models	Available as default feature in PM2125/ PM2225 and Expandable option in PM2130/ PM2230 meter model
Alarm conditions	23 set point driven standard alarms, 4 Unary alarms, 2 Digital inputs status
Application	Pulse output: configurable for energies upper / lower limit: configurable for 9 parameters with 14 set point: V L-L, V L-N, Amps, F, V-THD %, W-tot, VA-tot, VAR-tot, PF-avg
Display support	Available on PM2230/PM2225 (LCD type). In PM2130/ PM2125 meter, data is available through communication only
Set up and Configuration	Through set-up software
Analog inputs	
Measurement scale	4-20 mA
Input impedance	$\leq 300 \Omega$
Max source impedance	$> 500 \Omega$
Update rate	1 s
Accuracy	1 % of Full scale at ambient temp 0.1 %/K for de-rating
Voltage ratings	Typical 12 V (max 30 V)
Power Consumption	< 1.5 W
Isolation	2.5 kV RMS
Supported models	Expandable option in PM2130/PM2230 meter models
Application	Configurable for inputs from flow rates, RPM, fluid level, oil pressure, temperature measurement devices or transducers with option of 81 different Uni code selection. Configuration via set up software
Display	Available on PM2230 (LCD type). In PM2130 meter, data is available through communication only
Set up and configuration	Through set up software
Analog outputs	
Scale	4-20 mA
Load impedance	$\leq 600 \Omega$
Update rate	1 s
Accuracy	1 % of Full scale at ambient temp
Voltage ratings	Typical 12 V (max 30 V)
Power Consumption	< 1.5 W
Isolation	2.5 kV RMS
Supported models	Expandable option in PM2130/ PM2230 meter models
Application	Analog outputs can be associated to 40 different instantaneous parameters
Display	Available on PM2230 (LCD type). In PM2130 meter, data is available through communication only
Set-up & configuration	Through set-up software
Mechanical characteristics	
Mechanical dimension	90.5 mm W x 53 mm H x 14.67 mm D (without connector)
Weight	50 g

PM2000

PB120599



Digital Input Relay Output module

PM2000 series electrical characteristics of IO modules

Mechanical characteristics	
Mechanical dimension	90.5 mm W x 53 mm H x 14.67 mm D (without connector)
Weight	50 g
Relay Outputs	
Voltage rating	30 V DC 5A load 250 V AC 8A, PF=1.0 250 V AC 6A, PF=0.4
Output Frequency	0.5 Hz maximum (1 second ON / 1 second OFF)
Relay type	Mechanical, Form A, Potential free
Isolation	2.5 kV RMS
Supported models	Available as default feature in selected references in PM2125/PM2225 model. Expandable options in PM2130/PM2230 model.
Alarm conditions	23 set point driven standard alarms, 4 Unary alarms, 2
Application	Upper / lower limit: configurable for 10 parameters with 23 set points: V L-L, V L-N, Amps, F, V-THD %, W-tot, VA-tot, VAR-tot, PF-avg, last, present & predicted parameters for 3 power demands
Display and communication	Available on PM2230/PM2225 (LCD type). In PM2130/PM2125 meter, data is available through communication only
Set up and Configuration	Through ION set up software utility tool

PM2000

Feature set summary	PM2110	PM2120	PM2125C	PM2130	PM2210	PM2220	PM2225C	PM2230
Accuracy Class for Wh	1.0		0.5S		1.0		0.5S	
Accuracy Class for VARh	1.0							
Accuracy for VAh	±0.5 %							
Amps, per-phase, average and calculated neutral current	■							
Voltage, V L-N, V L-L, per-phase and average	■							
Power Factor	True PF	True PF Displacement PF ¹			True PF	True PF Displacement PF		
Frequency, any available phase	■							
Power: W, VA, VAR: per phase and total	■							
3-phase unbalance %	Current	Current Voltage ⁺⁴			Current	Current Voltage		
Demand parameters (Present, Last, Predicted and Peak for W, VA, VAR, A) Date and Time stamp for peak demand	■ (no timestamp)	■			■ (no timestamp)	■		
Energy: Wh, VAh, VARh (4 quadrant) Delivered (Import or Forward), Received (Export or Reverse)	Delivered, Received	Delivered, Received Total ⁺⁴ , Net ⁺⁴ , Last cleared ⁺⁴			Delivered, Received, Total, Net	Delivered, Received Total, Net, Last cleared		
Active load timer, meter operating timer, run hours and power outage counter	Through com							
THD %: Voltage L-N or L-L, Amps per phase	■							
Individual harmonics for Voltage, Current, per-phase		Up to 15th ⁺⁴	Up to 15th ⁺⁴	Up to 31st ⁺⁴		Up to 15th	Up to 15th ⁺⁴	Up to 31st
Min/ Max with real time clock For avg or total of V L-L, V L-N, Amps, PF, Hz, W, VA, VAR parameters with date and time stamp of occurrence	Through com							
RTC/battery ²		■	■	■		■		■
Communication	Pulse Output	RS-485			Pulse Output	RS-485		
Expandable Analog IO module ⁺⁵ PM2K2AIAO: 2 input & 2 output channels PM2K1AIAO: 1 input & 1 output channel				■				■
Expandable Digital IO module ³ PM2K2DIDO: 2 input & 2 output channels		Embedded		■		Embedded		■
Expandable DI RO module PM2K2DI2RO: 2 Digital input, 2 Mech Relay output channels Whetting output voltage: 24V DC, 8 mA max load		Embedded with 2DI/RO		■		Embedded with 2DI/RO		■
Customizable data logging up to 2 parameters. Option to select Power (W, VA, VAR) Bi-directional energy (±Wh, ±VAh, ±VARh), Demand (W, VA, VAR, A) with configurable interval and duration (e.g. 2 parameters for 60 days at 15 minutes interval)				■				■

⁺⁴ Through communication only

⁺⁵ Any one IO module can be used at a time with PM2130 or PM2230 meter. The control power range with IO module (including PM2125/ PM2225 references) shall be 72 to 304 V AC L-N or 90 to 304 V DC.

⁺⁶ Battery backup duration 3 years when meter is in Power OFF condition.

⁺⁷ Individual harmonics, 12am daily time snap shot and rate counter features (not available in PM2125/ PM2225 meters)

PM2000

PM2000 LCD display legend description

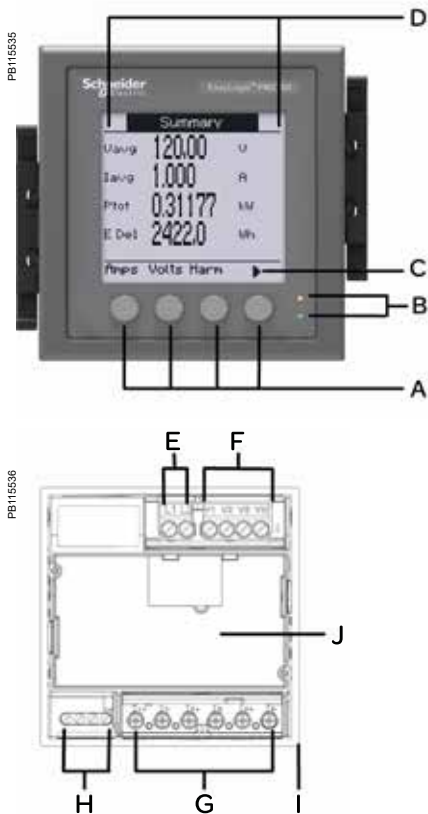

- A Menu selection buttons
- B Energy pulsing LED (red) Heartbeat / communications LED (green)
- C Navigation or menu selections:
 - ▲ Exit screen and go up one level
 - ▲ Move cursor up list of options
 - ▼ Move cursor down, display more options
 - ◀ Move cursor one character to the left
 - ▶ Scroll right and display more menu items
 - + Show next item in list or increase the highlighted value
 - Show previous item in list
- D Maintenance & alarm notification area
- E Control power
- F Voltage inputs
- G Current inputs
- H RS-485 / POP
- I Gasket
- J I/O channel slot - optional accessory for PM2230, embedded in PM2225 meter

PM2000 LED display legend description

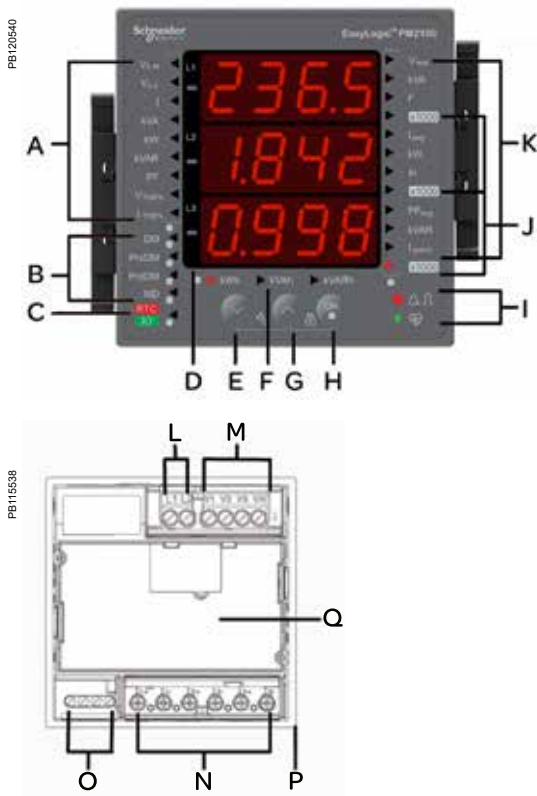

- A Phase measurements (VL-N, VL-L, I, kVA, kW, kVAR, PF, V-THD %, I-THD %)
- B Demand measurements (DM=Demand, PrsDM=Present demand, PrdDM=Predictor demand, MD=Maximum demand)
- C RTC Date & time
- D Negative indicator
- E Navigation key to navigate down
- F Energy readings Apparent energy, Active energy, Reactive energy
- G Navigation key to navigate up
- H OK Enter key
- I Energy pulsing LED (red) Heartbeat / communications LED (green)
- J x 1000 indicator
- K System measurements Vavg, kVA, F, Iavg, kW, In, PFavg, kVAR, Iunb
- L Control power L1, L2
- M Input voltage terminals V1, V2, V3, VN
- N Input current terminals I1+, I1-, I2+, I2-, I3+, I3-
- O RS-485 communications / POP terminals
- P Gasket
- Q I/O channel slot - optional accessory for PM2130, embedded feature in PM2125 meter

PM2000

PM2000 meter rear view

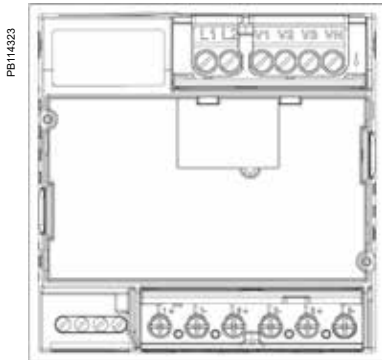

Meter installation



PM2000 multi-function meter mechanical dimensions

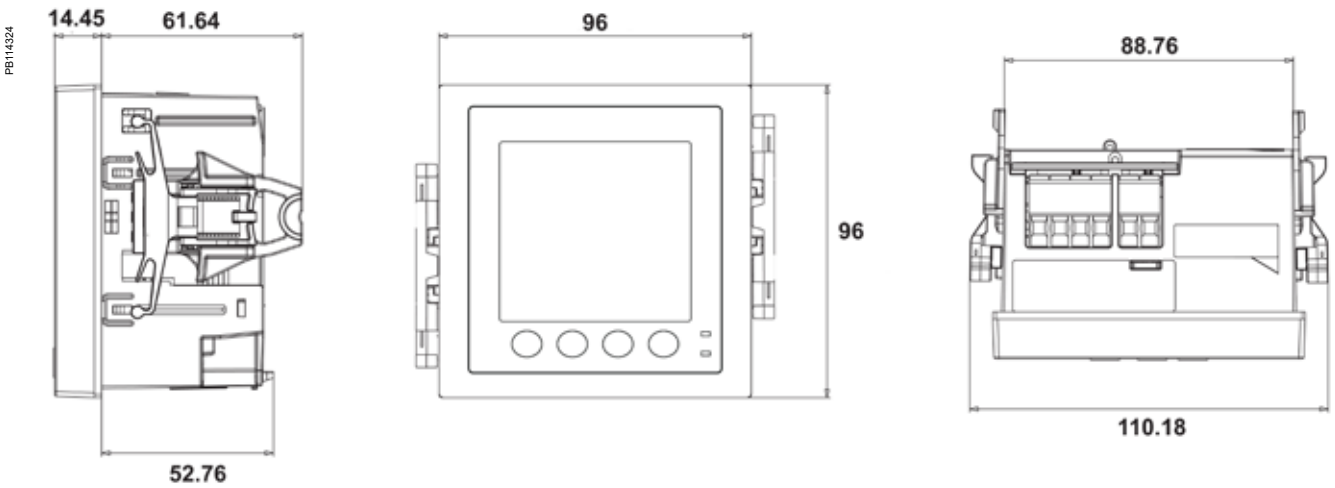

PM2000 Digital and Analog IO module mechanical dimensions

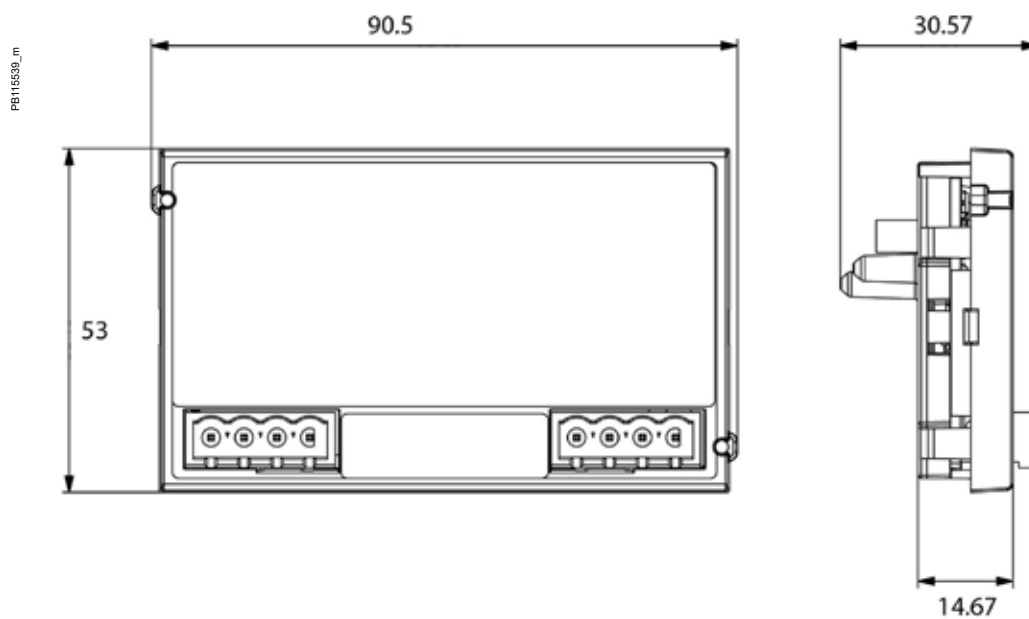

See the appropriate **Installation Guide** for correct installation instructions.

EasyLogic

PM2200R Quick Click series

The EasyLogic™ PM2200R multi-function power and energy meter with Quick Click CTs

Offering the same extensive measurement capabilities of the PM2200 meters - now with the option to significantly reduce installation time, cost, and complexity with new plug & play, 3-in-1 Quick Click CTs.

Applications

Cost management applications

- Bill checking to verify that you are only charged for the energy you use
- Aggregation of energy consumption and cost allocation per area, per usage, per shift or per time within the same facility
- Energy cost analysis per zone, per usage or per time period to optimise energy consumption

Network management applications

- Metering of electrical parameters to better understand the behaviour of your electrical distribution system
- Power quality analysis



PB110508

PM2200R



PM2200R meter

Introducing the new Quick Click enabled Easylogic PM2200R series, next generation power meter which offers all of the measurement capabilities of the PM2200 series with the added benefit of plug & play CT installation. For installers - time, labour, and rework savings of over 75 % compared to traditionally wired meters and CTs.

- Applications
 - Cost management:
 - Electrical installation remote monitoring
 - Energy accounting and balancing
 - Tenant and sub-billing
 - Panel instrumentation
 - Energy management
- Network management:
 - Power quality analysis: THD % and individual harmonics up to the 15th order (PM2200R)
 - Measurement of True PF and Displacement PF
 - Recording Min/Max values of instantaneous parameters with date & timestamp
 - Calculates % unbalance for voltage & current
- Main characteristics:
 - Simple CT connection and installation with Quick Click-enabled meters and CTs: A single RJ-45 port on the meter allows for direct connection to the RJ-45 port on Schneider Electric Quick Click CTs. As Quick Click CTs have a low voltage output, the shorting block required for traditional 5 A output CTs is no longer needed. CT input screw terminals on the meter, screw terminals on the CTs, and screw terminals on the shorting block are all eliminated with the Quick Click solution.
 - Easy to install: Mounts using two clips, no tools are required. Compact meter with 54 mm depth, connectable up to $480 \pm 10\%$ V AC Volts L-L without voltage transformers for installations compliant with measurement category III, and double insulated.
 - Easy to operate: Intuitive navigation with self guided menus and test LED at the front panel used for test and calibration of the meter on site or laboratory. Heart-beat LED indicates normal functioning and communication status if connected to RS-485 network.
 - Product standard compliance
 - Active energy Class 1.0 as per IEC 62053-21^{*1}
 - Reactive energy Class 1.0 as per IEC 62053-24 (partial compliance for reactive energy test clause only)
 - Power quality analysis: The PM2220R offers THD % measurements and Individual harmonics up to the 15th order.
 - Load management: Simultaneous display of peak, present, predicted & rising demands of all the four demand parameters (W, VA, VAR, Amps)
 - Billing: Tenant billing/utility meter cross check (where local regulations are not applicable).
 - Timer: Active load timer, meter operation timer and run hours timer. These features help advise maintenance requirements and scheduling.
 - Display type: Monochrome graphical LCD of 128 x 128 resolution with viewable area of 67 x 62.5 mm lets the users read all three phase measured values simultaneously. The bright anti-glare display features large characters and powerful backlighting for easy reading even in extreme lighting conditions and viewing angles. Intuitive menus, multi-language text, icons and graphics create a user-friendly environment to learn about your electrical network.

^{*1} Meters have been tested to ANSI C12.20 and IEC 62053-21 assuming an ideal CT

PM2200R

PB119510



METSECTV35xxx series CT

PB119511



METSECTV45xxx series CT

- Password: Field configurable password for securing set up information and prevent tampering of integrated values.
- Cyber security: Option for disabling RS-485 port through front panel keys against unauthorized access. It helps during installation and trouble shooting of communication network.
- LCD display: 5 digits for energy, 5 or 6 digits for other parameters, with auto scaling.
- Daily time snap shot (PM2220R): The values from summary page will be stored as snap shot and refreshed by a configurable time next day.
- Rate counters (PM2220R): 2 configurable counters display values in custom specified units based on energy recorded (e.g., kgCO₂ carbon emission or energy cost).
- Energy preset feature: For retrofit application.
- Suppression current: To disregard measurement of induced current or negligible current flowing in the circuit, settable from 5 mA to 99 mA.

Feature selection

Commercial ref. number	Model
Meter model	Description
METSEPM2210R	PM2210R power meter THD POP CL1.0 Quick Click LVCT
METSEPM2220R	PM2220R power meter 15th Har RS485 CI 1.0 Quick click RJ45 LVCT
LVCTs	LVCT Solid 3 in 1 RJ45
METSECTV25006	LVCT Solid Core 3 in 1 RJ45 25mm Ctr 60 A:1/3V
METSECTV25010	LVCT Solid Core 3 in 1 RJ45 25mm Ctr 100 A:1/3V
METSECTV25013	LVCT Solid Core 3 in 1 RJ45 25mm Ctr 125 A:1/3V
METSECTV25016	LVCT Solid Core 3 in 1 RJ45 25mm Ctr 160 A:1/3V
METSECTV35006	LVCT Solid Core 3 in 1 RJ45 35mm Ctr 60 A:1/3V
METSECTV35010	LVCT Solid Core 3 in 1 RJ45 35mm Ctr 100 A:1/3V
METSECTV35012	LVCT Solid Core 3 in 1 RJ45 35mm Ctr 120 A:1/3V
METSECTV35013	LVCT Solid Core 3 in 1 RJ45 35mm Ctr 125 A:1/3V
METSECTV35015	LVCT Solid Core 3 in 1 RJ45 35mm Ctr 150 A:1/3V
METSECTV35016	LVCT Solid Core 3 in 1 RJ45 35mm Ctr 160 A:1/3V
METSECTV35020	LVCT Solid Core 3 in 1 RJ45 35mm Ctr 200 A:1/3V
METSECTV35025	LVCT Solid Core 3 in 1 RJ45 35mm Ctr 250 A:1/3V
METSECTV45025	LVCT Solid Core 3 in 1 RJ45 45mm Ctr 250 A:1/3V
METSECTV45040	LVCT Solid Core 3 in 1 RJ45 45mm Ctr 400 A:1/3V
METSECTV45060	LVCT Solid Core 3 in 1 RJ45 45mm Ctr 600 A:1/3V
METSECTV45063	LVCT Solid Core 3 in 1 RJ45 45mm Ctr 630 A:1/3V
METSECTV29006	LVCT Solid Core 3 in 1 RJ45 29mm Ctr 60 A:1/3V
METSECTV29010	LVCT Solid Core 3 in 1 RJ45 29mm Ctr 100 A:1/3V
METSECTV29012	LVCT Solid Core 3 in 1 RJ45 29mm Ctr 120 A:1/3V
METSECTV29013	LVCT Solid Core 3 in 1 RJ45 29mm Ctr 125 A:1/3V
METSECTV29015	LVCT Solid Core 3 in 1 RJ45 29mm Ctr 150 A:1/3V
METSECTV29016	LVCT Solid Core 3 in 1 RJ45 29mm Ctr 160 A:1/3V
METSECTV29020	LVCT Solid Core 3 in 1 RJ45 29mm Ctr 200 A:1/3V
METSECTV70080	LVCT Solid Core 3 in 1 RJ45 70mm Ctr 800 A:1/3V
METSECTV70100	LVCT Solid Core 3 in 1 RJ45 70mm Ctr 1000 A:1/3V
METSECTV70125	LVCT Solid Core 3 in 1 RJ45 70mm Ctr 1250 A:1/3V

See your Schneider Electric representative for complete ordering information.

PM2200R

PB119504



PM2200R series meter - front display

PB119502



PM2220R series meter - rear view

PB119503



PM2220R series meter - underside view

PM2200R technical specifications

General	
Use on LV and MV systems with onsite programmable PT ratio	
Basic metering with THD %, Individual Harmonics, RTC and min/max readings	
Instantaneous rms values	
Current	Average line current of 3-phase, per-phase, and calculated neutral current
Voltage	Average voltage of L-L, L-N parameters, and per-phase
Frequency	Any available line
Real, reactive, and apparent power	Total and per-phase value
Displacement power factor	Average and per-phase signed, four quadrant
True Power Factor	Average and per-phase signed, four quadrant
% Unbalance	Among the phase for Amps, V L-N, V L-L
Energy values stored in non-volatile memory	
Four quadrant measurement for Delivered (Forward or Import) and Received (Reverse or Export) energy	Accumulated energy values for Active, Reactive & Apparent Energy parameters, quadrant basis Net & Total (absolute) values
Timer	Accumulated time counters for active load timer, meter operation timer, run hours and power outage counter
Old Registers	Facilitates retrieval of last cleared energy values
Demand values	
Current average	Present, Last, Predicted, Peak, and Peak Date Time
Active power	Present, Last, Predicted, Peak, and Peak Date Time
Reactive power	Present, Last, Predicted, Peak, and Peak Date Time
Apparent power	Present, Last, Predicted, Peak, and Peak Date Time
Demand sync methods	Thermal, Timed, Command Sync, and Clocked Sync
Demand calculation mode	Sliding, fixed and rolling block
Demand intervals	Settable from 1 to 60 minutes, in the step of 1 minute
Display	
PM2200 series	Full scape, monochrome graphical LCD of 128 x 128 resolution with viewable area of 67 x 62.5 mm
Visualization mode for signs	IEC or IEEE type in LCD display meter
Communication	
RS-485 serial	Channel connection Industry standard Modbus RTU protocol
Integration with software	SCADA / DCS / PMS / EMS / BAS / BMS software
Native Plug and Play support	Native plug-and-play support for: EcoStruxure Power Monitoring Expert, EcoStruxure Power SCADA Operation, ION Setup.
Min/Max values	
Minimum & Maximum value recording of 3-ph average or total	For 8 parameters, viz., V L-L, V L-N, Amps, PF, Hz, W, VA, VAR with date and time stamp, resettable separately through set up mode
Diagnostics	
Diagnostic page	Indicates LCD status, serial number, diag pages, OS & RS version
Rate 1 counter ⁺²	
kgCO ₂ emission (example)	Rate counter can be configured to display the CO ₂ emission in kgCO ₂ format based on the kWh measured either in delivered or received direction.
Rate 2 counter ⁺²	
Tariff counter (example)	Rate counter can also be configured to calculate the electricity cost based on the energy consumption in customized currency format.
Daily time snap shot ⁺²	
Daily time snap shot	Snap shot of Avg Voltage, Avg Current, Total Active Power & Energy delivered as measured by the meter at configurable time of day. The static page will be refreshed with new values at a configured time next day

+2 Available in PM2220R

PM2200R

PB119508



PM2200R with 35 mm CT attached

Electrical characteristics	
Type of measurement	True RMS 64 samples per cycle
Measurement accuracy	
Current, average & per-phase	±0.5 %
Voltage average & per-phase	±0.5 %
Frequency	±0.05 %
Power Factor, average & per-phase	±0.01
Power (W-Active, VA- Apparent)	±0.5 %
Power (VAR- Reactive)	±1.0 %
Real / Active Energy (Wh)	Class 1.0 as per IEC 62053-21
Reactive Energy	Class 1.0 as per IEC 62053-24
Apparent Energy	±0.5 %
THD % and Individual Harmonics- V & A	±5 % FS for THD % & Individual harmonics
Input-voltage	
VT primary	999 kV L-L max, secondary voltage depends on VT ratio
U nominal	277 V L-N/480 V L-L
Measured V with full range	20-277 V L-N/35 - 480 V L-L, cat III 20-347 V L-N/35 - 600 V L-L, cat II
Permanent overload	750 V AC L-L
Measured range	0.00333 V to 0.4 V
Frequency nominal	50/60 Hz
Input-current	
CT ratings	Compatible with Schneider Electric Quick Click CTs with available primary current ratings of 60 A-1600 A Secondary 0.333 V
Frequency nominal	50/60 Hz
AC control power	
Operating range	44 - 277 V AC
Burden	<6 VA at 277 V AC L-N
Frequency	45 to 65 Hz
Ride-through time	100 ms typical at 120 V AC and maximum burden 400 ms typical at 230 V AC and maximum burden
DC control power	
Operating range	48-277 V DC ±10 %
Burden	< 2 W at 277 V DC
Ride-through time	50 ms typical at 125 V DC and maximum burden
Real time clock	
RTC with battery backup	3 years (when meter is in Power OFF condition - PM2220R)
Displays update	
Instantaneous	1 s
Demand	15 s
Harmonics	5 s
Wiring configuration	
User programmable	1ph, 2w, L-N 1ph, 2w, L-L 1ph, 3w, L-L with N (2phase) 3ph, 3w, Delta, Ungrounded 3ph, 3w, Delta, Corner Grounded 3ph, 3w, Wye, Ungrounded 3ph, 3w, Wye Grounded 3ph, 3w, Wye, Resistance Grounded 3ph, 4w, Open Delta, Center-Tapped 3ph, 4w, Delta, Center-Tapped 3ph, 4w, Wye, Ungrounded 3ph, 4w, Wye Grounded 3ph, 4w, Wye, Resistance Grounded

PM2200R

PM2200R series	
Mechanical characteristics	
Weight	~ 300 g
IP degree of protection	IP54 front side, IP30 meter body as per IEC 60529 Upgrade to IP65 front side with optional accessory kit METSEIP65OP96X96FF
Material	Polycarbonate meets UL 94V-0 flammability rating
Dimensions W x H x D	96 x 96 x 54 mm maximum (depth of the meter from housing mounting flange) and 13 mm (protrusion of meter from housing flange).
Mounting position	Vertical
Panel thickness	5 mm maximum
Environmental characteristics	
Operating temperature	Meter -10 to +60 °C (14 to 140 °F)
Storage temperature	Meter -25 to +70 °C (-13 to 158 °F)
Humidity rating	5 to 95 % RH non condensing
Pollution degree	2
Altitude	≤2000 m (6562 ft) Category III
Product life	Minimum 7 years
Electromagnetic compatibility (tested as per IEC 61326-1)	
Electrostatic discharge	IEC 61000-4-2
Immunity to radiated field	IEC 61000-4-3
Immunity to fast transients	IEC 61000-4-4
Immunity to impulse waves	IEC 61000-4-5
Conducted immunity	IEC 61000-4-6
Immunity to magnetic fields	IEC 61000-4-8
Immunity to voltage dips	IEC 61000-4-11
Emissions	Emissions FCC Part 15 Class A/CE
Safety	
Europe	CE, as per IEC 61010-1 Ed-3
US and Canada	cULus as per UL61010-1 and CAN/CSA-C22.2 No. 61010-1, for 480 V AC
Measurement Category (Voltage and Current inputs)	CAT III up to 480 V L-L CAT II up to 600 V L-L
Overvoltage Category (Control power)	CAT III up to 300 V L-N
Dielectric	As per IEC/UL 61010-1 Ed-3
Protective Class	II, Double insulated for user accessible parts
Green premium	EOL, REACH, PEP, RoHS complied
Other certification	RCM (Australia), EAC (Russia)
Communication	
RS-485 port (PM2220R)	Modbus RTU: 2-Wires, with ground & shield, 4800, 9600, 19200 or 38400 baud, Parity - Even, Odd, None, 1 stop bit if parity is Odd or Even, 2 stop bits if None DLF3000: Firmware update through communication port
Pulse Output – POP (PM2210R)	Max 40 V DC, 20 mA 20 ms ON time Configurable pulse weight from 1 to 9999000 pulses/k_h (kWh, kVAh, or kVARh)
Isolation	2.5 kV RMS, double insulated
Protection features	Password protected for set-up & clearing energy and Min/Max data
Display language	English, Spanish, French, Chinese, German, Portugese, Russian, Turkish
Technical publication	Printed installation guide (IG) with the meter in multi language (EN, ES, FR, DE, PT, RU, TR, ZH)
Human machine interface	
Display type	LCD display: Monochrome graphical LCD of 128 x128 mm resolution with viewable area of 67 x 62.5 mm
Keypad	4 buttons for intuitive navigation of HMI/ UI pages
CAL LED Indicator	Red colour, meter constant is configurable from 1 to 9999000 pulses/k_h (kWh, kVAh, or kVARh)
Comm. activity	Green LED (for indicating RS-485 interface or heartbeat pulse)

PM2200R

PM2200R meter rear

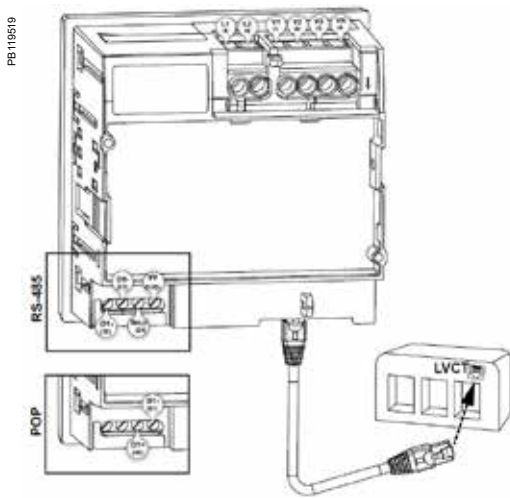

Feature set summary	PM2210R	PM2220R
Accuracy Class for Wh		1.0
Accuracy Class for VARh		1.0
Accuracy for VAh		±0.5 %
Amps, per-phase, average and calculated neutral current		■
Voltage, V L-N, V L-L, per-phase and average		■
Power Factor	True PF	True PF Displacement PF
Frequency, any available phase		■
Power: W, VA, VAR: per phase and total		■
3-phase unbalance %	Current	Current Voltage
Demand parameters (Present, Last, Predicted and Peak for W, VA, VAR, Amps)	■	■
Date and Time stamp for peak demand	(no timestamp)	
Energy: Wh, VAh, VARh (4 quadrant) Delivered (Import or Forward), Received (Export or Reverse)	Delivered, Received, Total, Net	Delivered, Received Total, Net, Last cleared
Active load timer, meter operating timer, run hours and power outage counter		■
THD %: Voltage L-N or L-L, Amps per phase		■
Individual harmonics for Voltage, Current, per-phase		Up to 15th
Min/ Max with real time clock For avg or total of V L-L, V L-N, Amps, PF, Hz, W, VA, VAR parameters with date and time stamp of occurrence		■
RTC/battery		■
Communication	Pulse Output	RS-485
Daily time snap shot of Avg Voltage, Avg Current, Total active power & Energy delivered as measured every day at a configurable time		■

PM22xx panel grouping

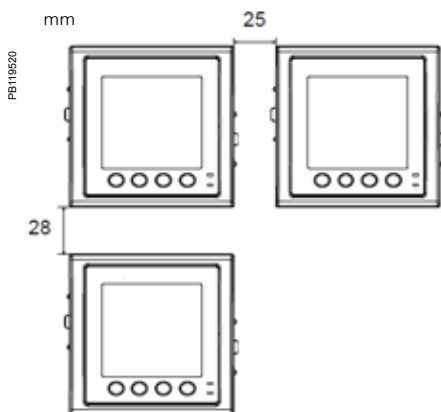

PM22xx Meter installation

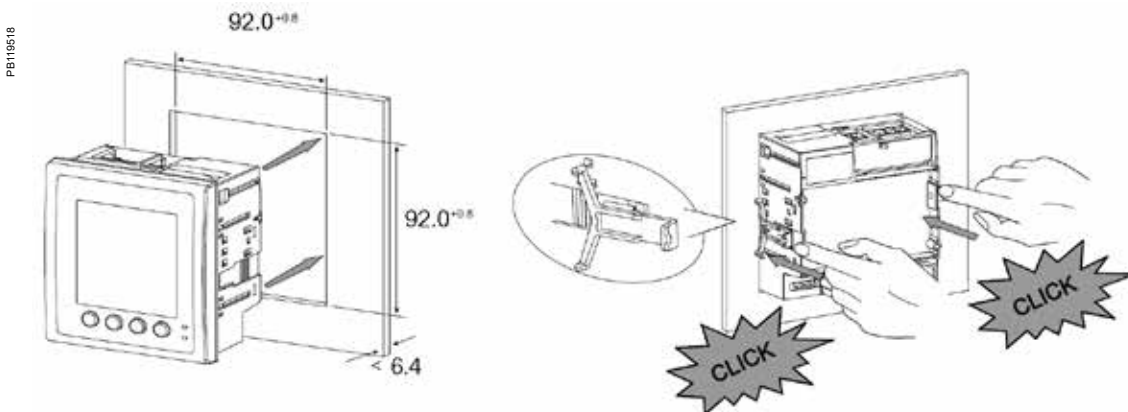

See the appropriate **Installation Guide** for correct installation instructions.

PM2200R

PM2200R multi-function meter mechanical dimensions

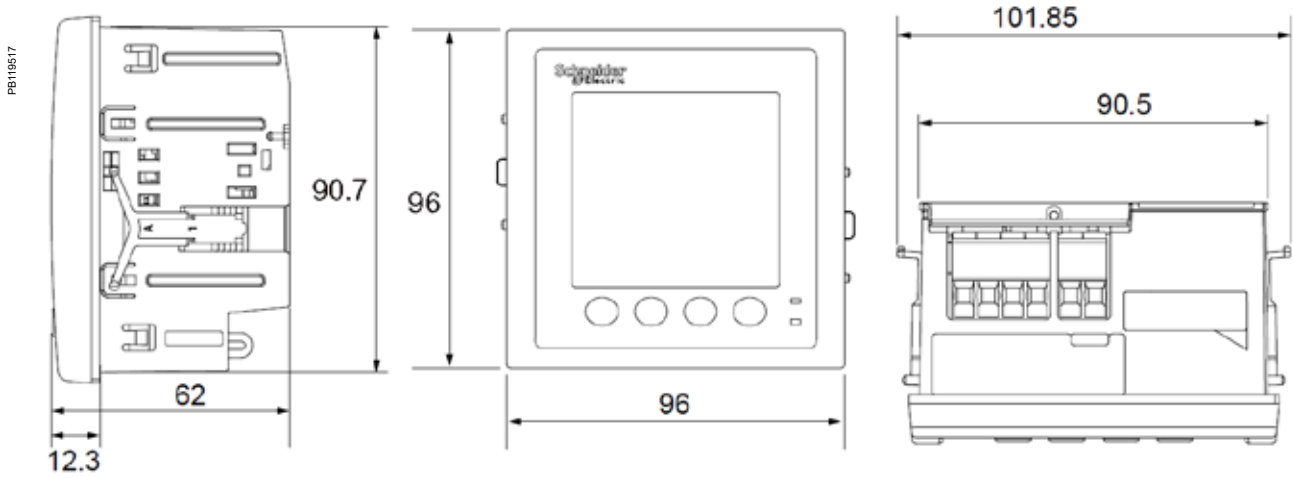

SECTV25xxx 3-in-1 LVCT mechanical dimensions

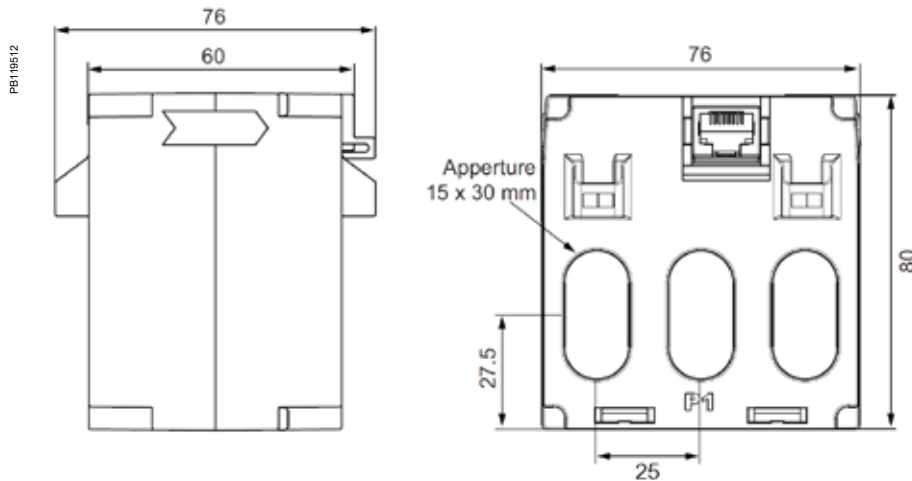

SECTV29xxx 3-in-1 LVCT mechanical dimensions

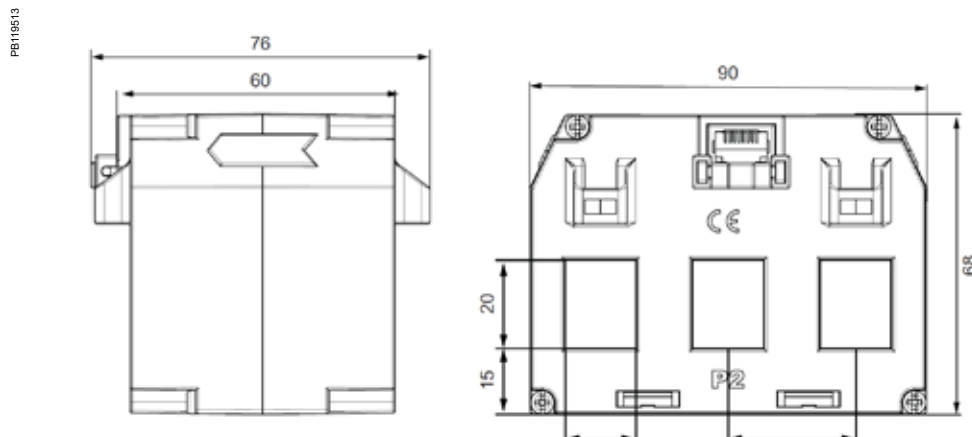

See the appropriate **Installation Guide** for correct installation instructions.

PM2200R

SECTV35xxx 3-in-1 LVCT mechanical dimensions

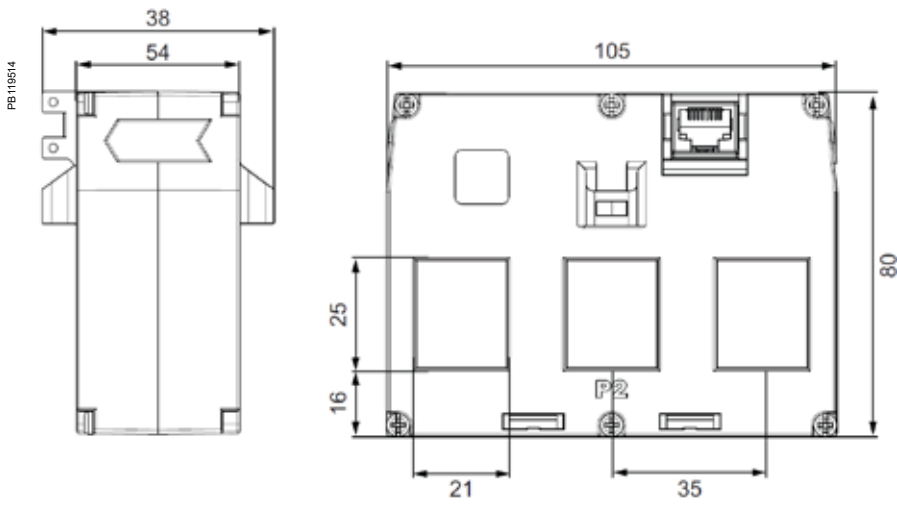

SECTV45xxx 3-in-1 LVCT mechanical dimensions

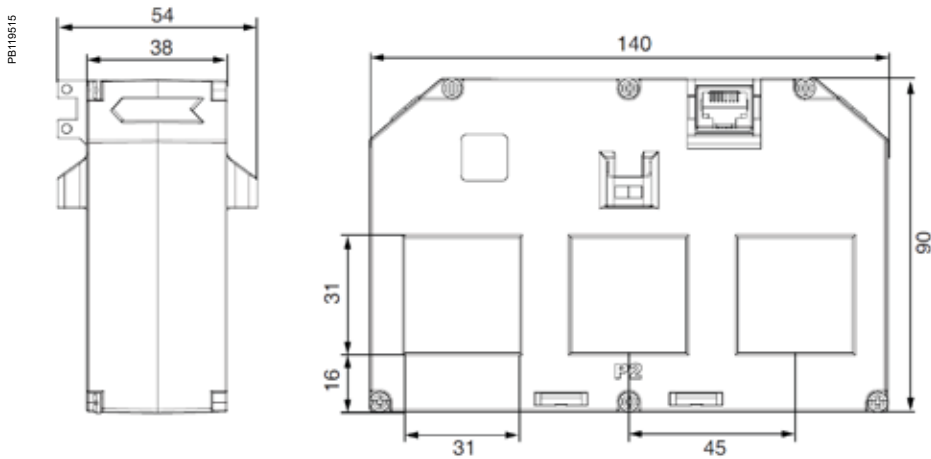

SECTV70xxx 3-in-1 LVCT mechanical dimensions

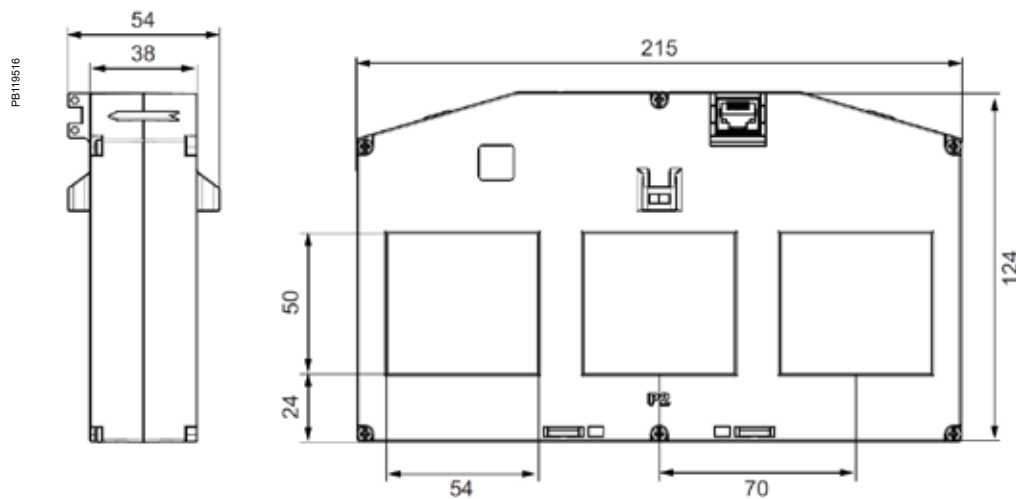

See the appropriate **Installation Guide** for correct installation instructions.

EasyLogic Commercial Reference Numbers

Comm. reference number	Description
DM1000 series	
METSEDM1110	DM1110 1-ph Amps digital panel meter
METSEDM1210	DM1210 1-ph Volts digital panel meter
METSEDM1310	DM1310 1-ph Frequency digital panel meter
DM3000 series	
METSEDM3110	DM3110 3-ph Amps digital panel meter
METSEDM3210	DM3210 3-ph Volts digital panel meter
DM6000H series	
METSEDM6000HCL10NC	DM6000H VAF PF CI 1.0 digital panel meter
DM6200 series	
METSEDM6200HCL10RS	DM6200H VAF PF CI 1.0 RS-485 digital panel meter
METSEDM6220HCL1	DM6220H VAF PF CI 1.0 RS-485 digital panel meter
METSEDM6220HCL1LVD	DM6220H VAF PF CI 1.0 RS-485 digital panel meter
EM1250H	
METSEEM1250HCL1	EM1250H CI 1.0 RS-485 power & energy meter
PM1120H series	
METSEPM1120HCL10RS	PM1120H LED CI 1.0 RS-485 One power and energy meter
METSEPM1120HCL05RS	PM1120H LED CI 0.5 RS-485 One power and energy meter
METSEPM1125HCL10RS	PM1125H LED CI 1.0 RS-485 Three power and energy meter
METSEPM1125HCL1LVD	PM1125H LED CI 1.0 Control power 9 to 36V DC RS-485 Three power and energy meter
METSEPM1225HCL1	PM1225H LCD CI 1.0 RS-485 Three power and energy meter
METSEPM1225HCL5	PM1225H LCD CI 0,5 RS-485 Three power and energy meter
METSEPM1225HCL1LVD	PM1225H LCD CI 1.0 Control power 9 to 36V DC RS-485 Three power and energy meter
METSEPM1225HCL5LVD	PM1225H LCD CI 0.5 Control power 9 to 36V DC RS-485 Three power and energy meter
PM1130H series	
METSEPM1130HCL05RS	PM1130H LED CI 0.5 RS-485 dual source power and energy meter
METSEPM1230HCL1	PM1230H LCD CI 1.0 RS-485 dual source power and energy meter
METSEPM1230HCL5LVD	PM1230H LCD CI 0.5 Control power 9 to 36V DC RS-485 dual source power & energy meter
PM2000 series	
METSEPM2110	PM2110 LED VAF P&E THD Pulse CI 1.0 power and energy meter
METSEPM2120	PM2120 LED VAF P&E THD RTC RS-485 CI 1.0 power and energy meter
METSEPM2125C2AI2AO	PM2125C LED VAF P&E THD 15th Harmonics RTC 2 Analog Inputs 2 Analog outputs RS-485 CI 0.5S power and energy meter
METSEPM2125C2DI2RO	PM2125C LED VAF P&E THD 15th Harmonics RTC 2 Digital Inputs 2 Relay outputs RS-485 CI 0.5S power and energy meter
METSEPM2130	PM2130 LED VAF P&E THD 31st Mar RS-485 CI 0.5 power and energy meter
METSEPM2210	PM2210 LCD VAF P&E THD Pulse CI 1.0 power and energy meter
METSEPM2220	PM2220 LCD VAF P&E THD RTC RS-485 CI 1.0 power and energy meter
METSEPM2225C2AI2AO	PM2225C LCD VAF P&E THD 15th Harmonics RTC 2 Digital Inputs 2 Relay outputs RS-485 CI 0.5S power and energy meter
METSEPM2225C2DI2RO	PM2225C LCD VAF P&E THD 15th Harmonics RTC 2 Digital Inputs 2 Relay outputs RS-485 CI 0.5S power and energy meter
METSEPM2230	PM2230 LCD VAF P&E THD 31st Har RS-485 CI 0.5 power and energy meter
METSEPM2210R	PM2210R LCD Pulse RSJ45 LVCT CI 1.0 power and energy meter
METSEPM2220R	PM2220R LCD RS-485 RSJ45 LVCT CI 1.0 power and energy meter
METSEPM2KDGTLIO22	PM2x30 Digital IO Module with 2 channels each
METSEPM2KANLGIO22	PM2x30 Analog IO module with 2 channels each
METSEPM2KANLGIO11	PM2x30 Analog IO module with 1 channel each
METSEPM2K2DI2RO	PM2x30 Digital Input and Relay Output Module with 2 channels each

See your Schneider Electric representative for complete ordering information.

EasyLogic Commercial Reference Numbers ctd.

Comm. reference number	Description
PM2200R series	LVCT Solid 3 in 1 RJ45
METSECTV25006	LVCT Solid Core 3 in 1 RJ45 25mmCtr 60 A:1/3V
METSECTV25010	LVCT Solid Core 3 in 1 RJ45 25mmCtr 100 A:1/3V
METSECTV25013	LVCT Solid Core 3 in 1 RJ45 25mmCtr 125 A:1/3V
METSECTV25016	LVCT Solid Core 3 in 1 RJ45 25mmCtr 160 A:1/3V
METSECTV35006	LVCT Solid Core 3 in 1 RJ45 35mmCtr 60 A:1/3V
METSECTV35010	LVCT Solid Core 3 in 1 RJ45 35mmCtr 100 A:1/3V
METSECTV35012	LVCT Solid Core 3 in 1 RJ45 35mmCtr 120 A:1/3V
METSECTV35013	LVCT Solid Core 3in1 RJ45 35mmCtr 125 A:1/3V
METSECTV35015	LVCT Solid Core 3in1 RJ45 35mmCtr 150 A:1/3V
METSECTV35016	LVCT Solid Core 3in1 RJ45 35mmCtr 160 A:1/3V
METSECTV35020	LVCT Solid Core 3in1 RJ45 35mmCtr 200 A:1/3V
METSECTV35025	LVCT Solid Core 3in1 RJ45 35mmCtr 250 A:1/3V
METSECTV45025	LVCT Solid Core 3in1 RJ45 45mmCtr 250 A:1/3V
METSECTV45040	LVCT Solid Core 3in1 RJ45 45mmCtr 400 A:1/3V
METSECTV45050	LVCT Solid Core 3in1 RJ45 45mmCtr 500 A:1/3V
METSECTV45060	LVCT Solid Core 3in1 RJ45 45mmCtr 600 A:1/3V
METSECTV45063	LVCT Solid Core 3in1 RJ45 45mmCtr 630 A:1/3V
METSECTV29006	LVCT Solid Core 3in1 RJ45 29mmCtr 60 A:1/3V
METSECTV29010	LVCT Solid Core 3in1 RJ45 29mmCtr 100 A:1/3V
METSECTV29012	LVCT Solid Core 3in1 RJ45 29mmCtr 120 A:1/3V
METSECTV29013	LVCT Solid Core 3in1 RJ45 29mmCtr 125 A:1/3V
METSECTV29015	LVCT Solid Core 3in1 RJ45 29mmCtr 150 A:1/3V
METSECTV29016	LVCT Solid Core 3in1 RJ45 29mmCtr 160 A:1/3V
METSECTV29020	LVCT Solid Core 3in1 RJ45 29mmCtr 200 A:1/3V
METSECTV70080	LVCT Solid Core 3in1 RJ45 70mmCtr 800 A:1/3V
METSECTV70100	LVCT Solid Core 3in1 RJ45 70mmCtr 1000 A:1/3V
METSECTV70125	LVCT Solid Core 3in1 RJ45 70mmCtr 1250 A:1/3V
Cables	
DCEPCURJX5GYM	Category 5e, Patch Cord, UTP, 0.5 M, Grey
DCEPCURJ01GYM	Category 5e, Patch Cord, UTP, 1 M, Grey
DCEPCURJ02GYM	Category 5e, Patch Cord, UTP, 2 M, Grey
DCEPCURJ03GYM	Category 5e, Patch Cord, UTP, 3 M, Grey
DCEPCURJ05GYM	Category 5e, Patch Cord, UTP, 5 M, Grey
DCEPCURJ10GYM	Category 5e, Patch Cord, UTP, 10 M, Grey

See your Schneider Electric representative for complete ordering information.

Schneider Electric Industries SAS
35, Rue Joseph Monier,
CS 30323
F - 92506 Rueil Malmaison Cedex

RCS Nanterre 954 503 439
Capital social 896 313 776
www.schneider-electric.com

August 2020
EasyLogic Power Metering Catalog
PLSED310053EN

As standards, specifications and designs develop from time to time, please ask for confirmation of the information given in this document.

Design: Schneider Electric
Photos: Schneider Electric

Over 75 % of Schneider Electric products
have been awarded the Green Premium ecolabel.

© 2020 - Schneider Electric - All rights reserved



Life Is On

Schneider
Electric